

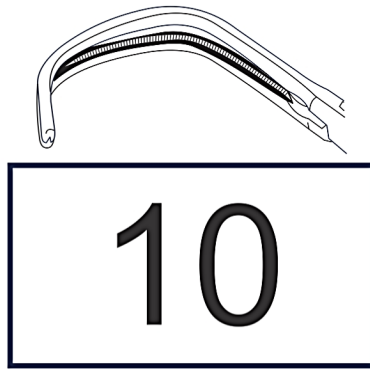

Surgical Instruments

Crimson International is proudly the most sought after name in the field of Medical Surgical Instruments. Since its birth, the chief aim of our company has been to utilize all its energies, manpower and technology towards developing superior quality instruments, with special emphasis on them being technically precise as well as user friendly. In order to serve the interest and meet the requirement of our customers, we endeavor to best of our abilities to improve our existing line and also introduce new products.



Cardio Vascular Surgery

INTERNATIONAL CRIMSON



Diethrich

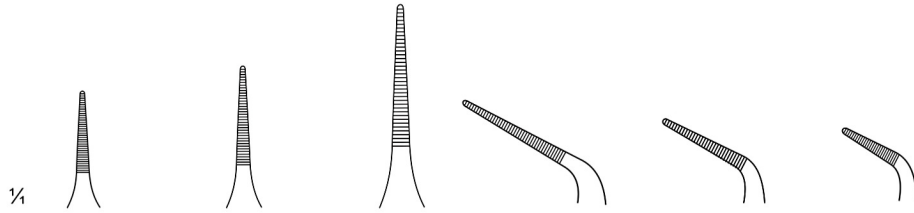

	DC10-001-49	DC10-001-53	DC10-001-59	DC10-003-43	DC10-003-45	DC10-003-50
Length	49mm	53mm	59mm	43mm	45mm	50mm
Jaws	8mm	12mm	20mm	8mm	12mm	20mm
Weight	3 gr.	3 gr.	3 gr.	3 gr.	3 gr.	3 gr.
Pressure	80 gr.	80 gr.	80 gr.	80 gr.	80 gr.	80 gr.

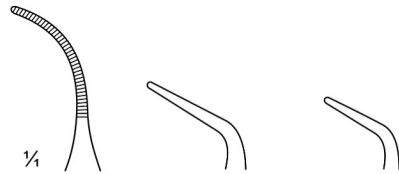

	DC10-005-54	DC10-007-43	DC10-007-49
Length	54mm	43mm	49mm
Jaws	20mm	13mm	18mm
Weight	3 gr.	3 gr.	3 gr.
Pressure	80 gr.	80 gr.	80 gr.



DeBakey

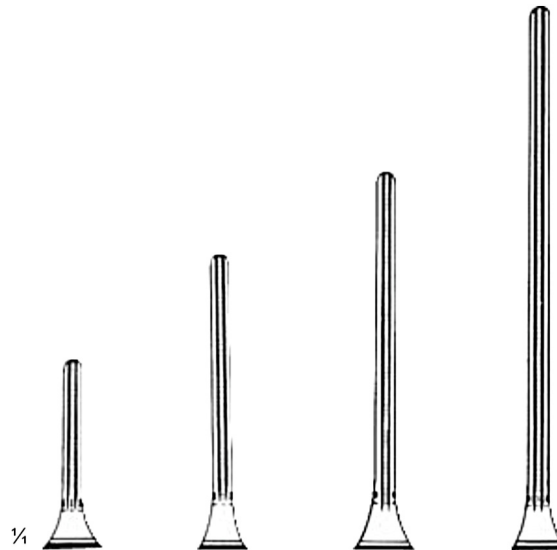

	DC10-009-08	DC10-009-09	DC10-009-10	DC10-009-12
Overall Length	80mm	90mm	105mm	125mm
Jaw Length	20mm	30mm	45mm	68mm
Weight	10 gr.	11 gr.	12 gr.	14 gr.



DeBakey

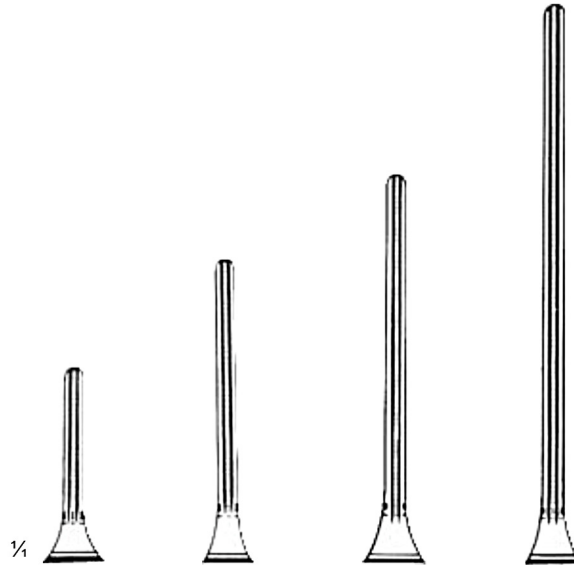

	DC10-011-08	DC10-011-09	DC10-011-10	DC10-011-12
Overall Length	75mm	85mm	95mm	115mm
Jaw Length	20mm	30mm	45mm	68mm
Weight	10 gr.	11 gr.	12 gr.	14 gr.

Gregory "Soft" Carotid Bulldog Clamps



	DC10-013-08	DC10-013-11	DC10-013-10	DC10-013-11
Overall Length	90mm	110mm	105mm	110mm
Jaw Length	27mm	44mm	55mm	
Weight	11 gr.	12 gr.	12 gr.	12 gr.

Modifizierte Gregory™ Soft "Bulldogklemmen"

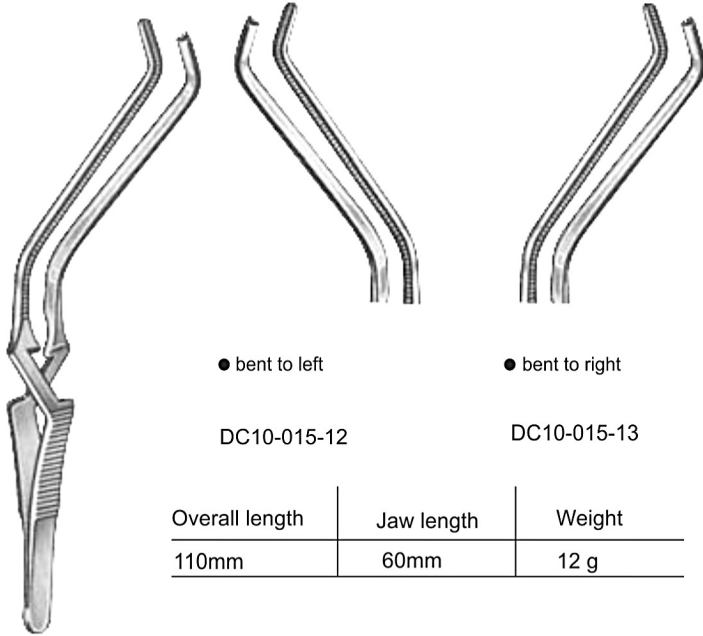

● bent to left

DC10-015-12

● bent to right

DC10-015-13

Overall length	Jaw length	Weight
110mm	60mm	12 g

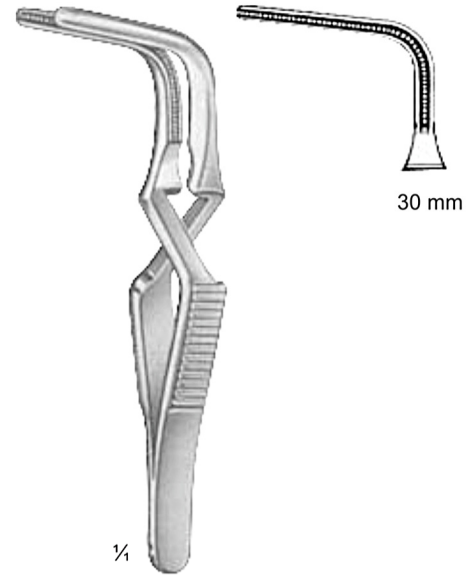

¼

Santulli
DC10-017-70
7cm/2¾"



Glover

¼

	DC10-019-05	DC10-019-07	DC10-019-09	DC10-019-11
Overall Length	50mm	68mm	85mm	105mm
Jaw Length	20mm	30mm	43mm	56mm
Weight	5 gr.	9 gr.	12 gr.	14 gr.

Closing pressure adjustable



Glover

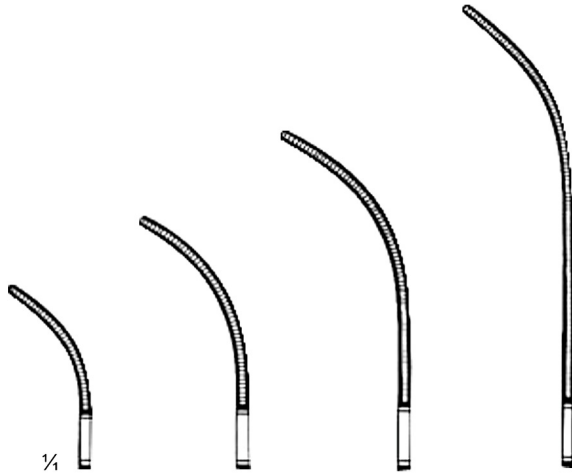

	DC10-021-05	DC10-021-07	DC10-021-08	DC10-021.10
Overall Length	46mm	64mm	78mm	100mm
Jaw Length	20mm	30mm	43mm	56mm
Weight	5 gr.	9 gr.	12 gr.	14 gr.

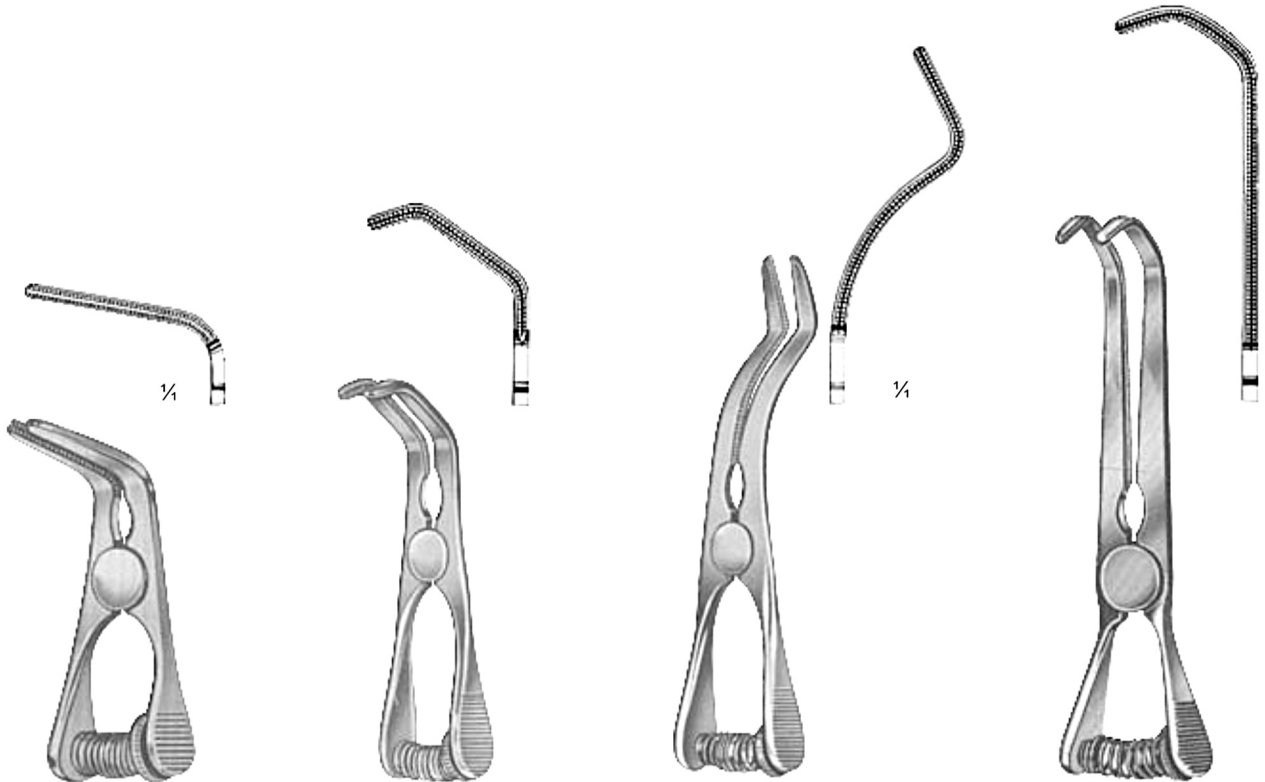

Glover
55mm
DC10-023-55

DeBakey-Satinsky
55mm DC10-025-55
65mm DC10-027-65



DeBakey-Carotid
90mm
DC10-027-90

DeBakey-Satinsky
100mm
DC10-027-99

INTERNATIONAL CRIMSON

Micro Bulldog Clamps

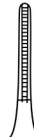
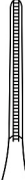

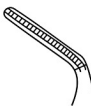
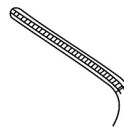
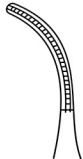
	 DC10-029-47	 DC10-029-51	 DC10-029-57	 DC10-031-44	 DC10-031-46	 DC10-031-49	 DC10-031-54
Overall Length	47mm	51mm	57mm	44mm	46mm	49mm	54mm
Jaw Length	10mm	14mm	20mm	10mm	14mm	20mm	20mm
Weight	3 gr.	3 gr.	3 gr.	3 gr.	3 gr.	3 gr.	3 gr.
Pressure	180 gr.	180 gr.	180 gr.	180 gr.	180 gr.	180 gr.	180 gr.

DeBakey-Diethrich

Applying Forceps for Bulldog Clamps

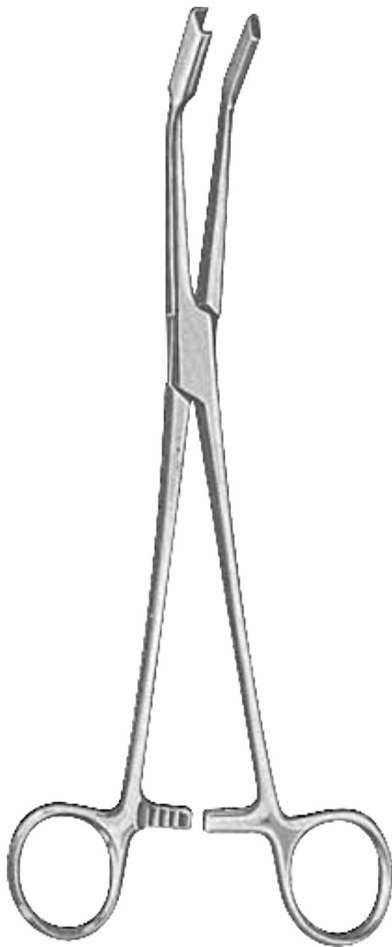

Johns-Hopkins
DC10-033-23
23cm/9"

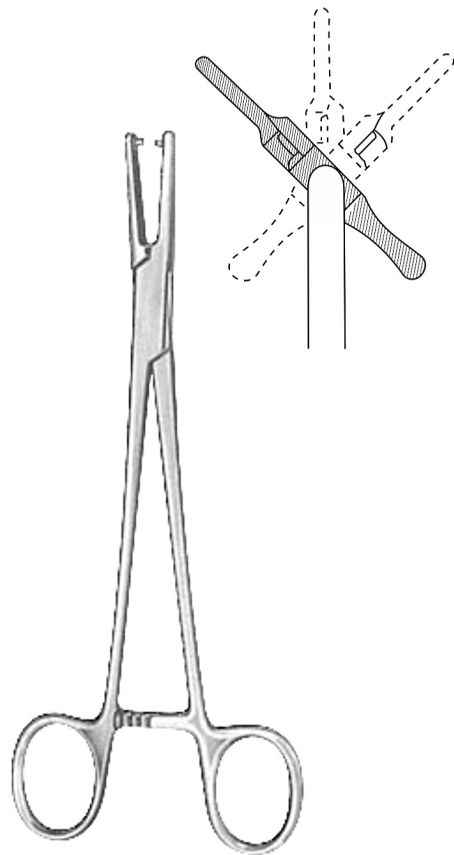
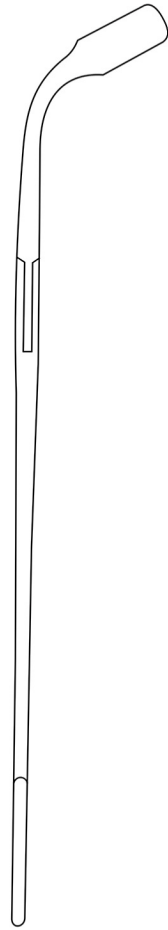

Wickham
DC10-035-24
24cm/9 1/2"
Applying forceps for
Bulldog Clamps Wickham Mini

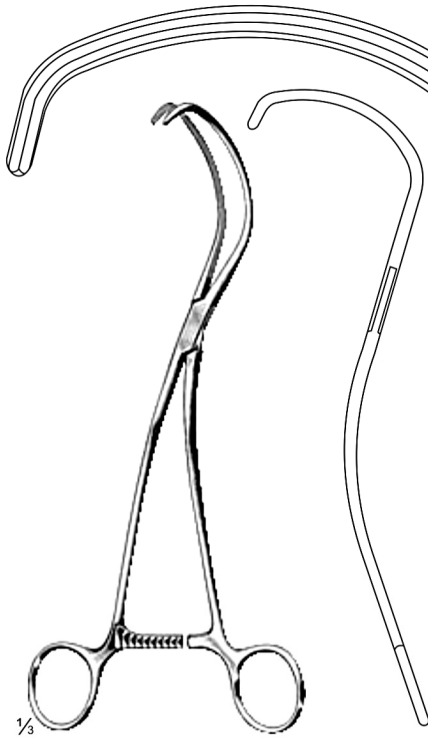

Derra
DC10-053-24
24 cm/9 1/2"

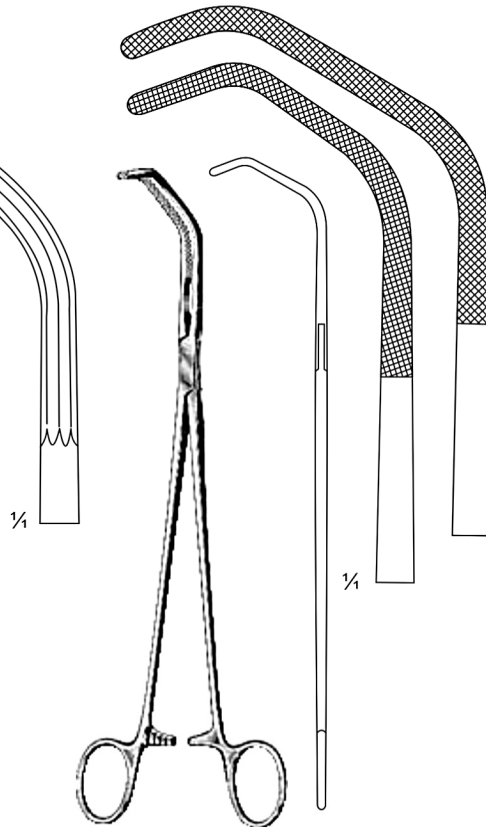

Satinsky
DC10-055-26 = Fig. 1
DC10-057-26 = Fig. 2
26.5 cm/10 1/2"

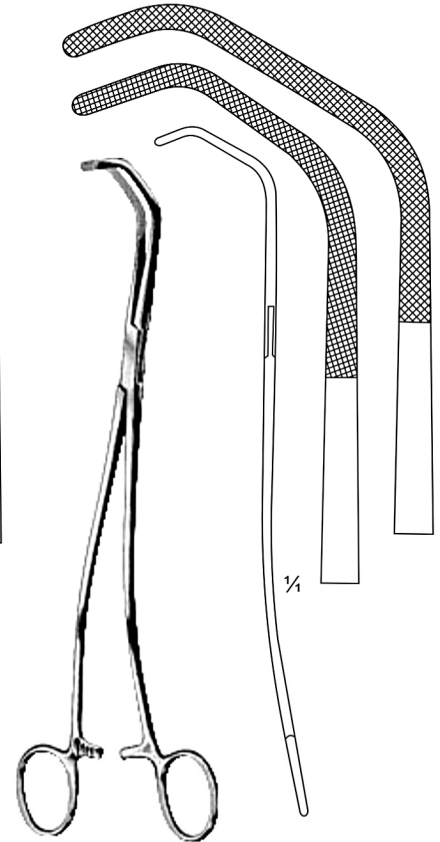

Satinsky
DC10-059-26 = Fig. 1
DC10-061-26 = Fig. 2
26.5 cm/10 1/2"

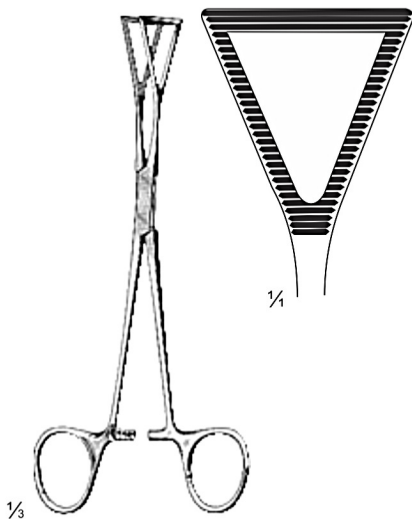

Lovelace
DC10-063-20
20 cm/8"



Lovelace
DC10-065-20
20 cm/8"



Johns Hopkins
22 cm/8 3/4"

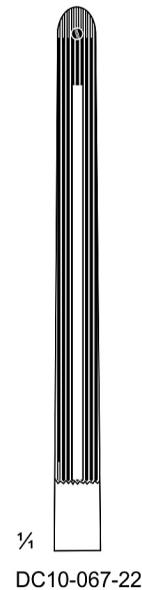

DC10-067-22

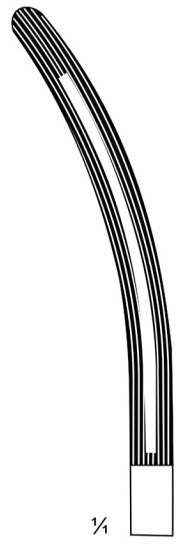

DC10-069-22

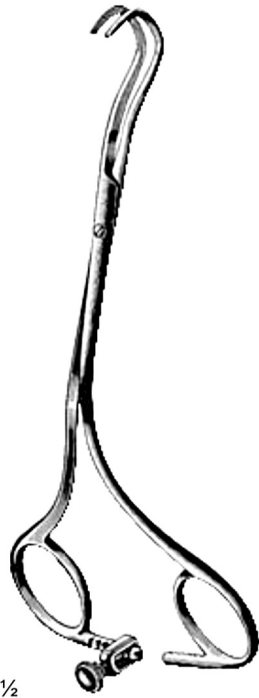

1/2

Derra
DC10-071-18 - DC10-081-18
18 cm/7"



1/4

DC10-071-18



1/4

DC10-073-18



1/4

DC10-075-18

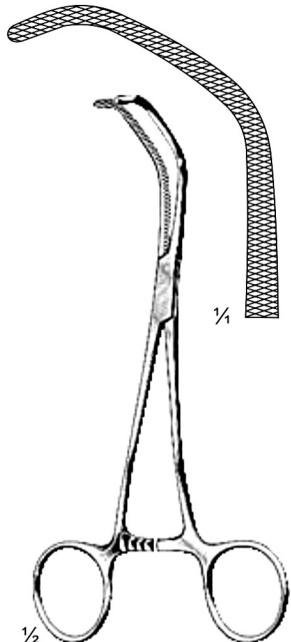

1/2

Baby-Satinsky
DC10-077-15
15 cm/6"

1/4

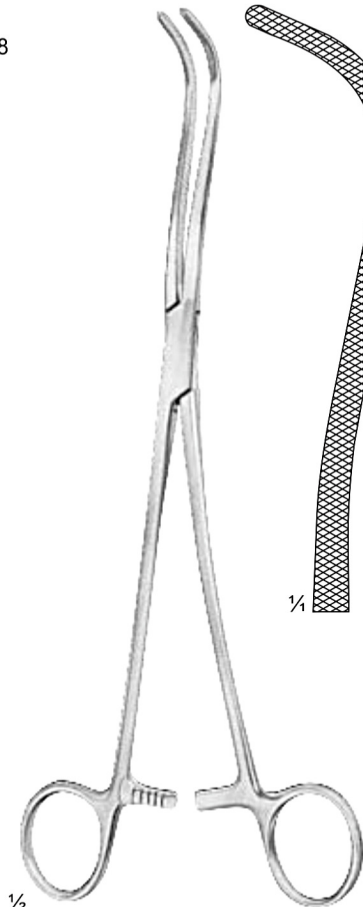

1/2

Harken
DC10-079-24
24 cm/9 1/2"

1/4

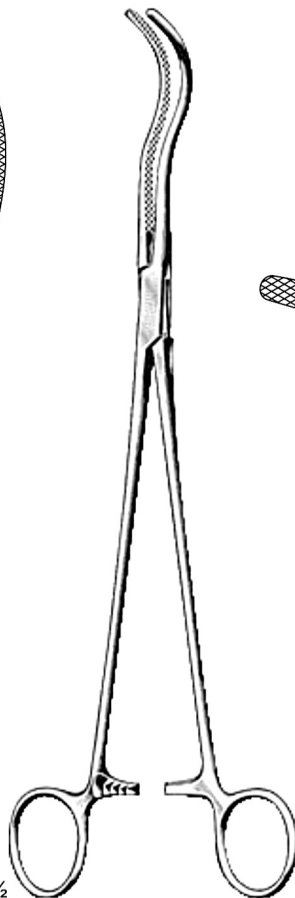

1/2

Harken
24 cm/9 1/2"

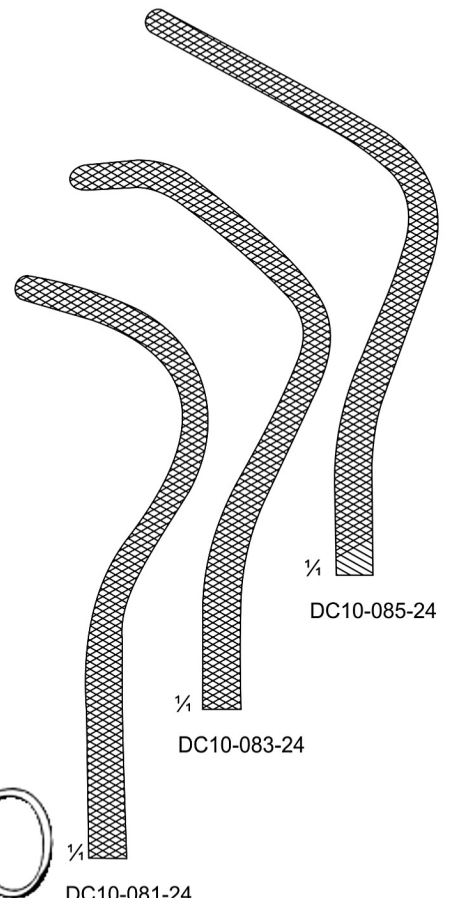

1/4

DC10-081-24

1/4

DC10-083-24

1/4

DC10-085-24



DeBakey
DC10-109-26
26 cm / 10"

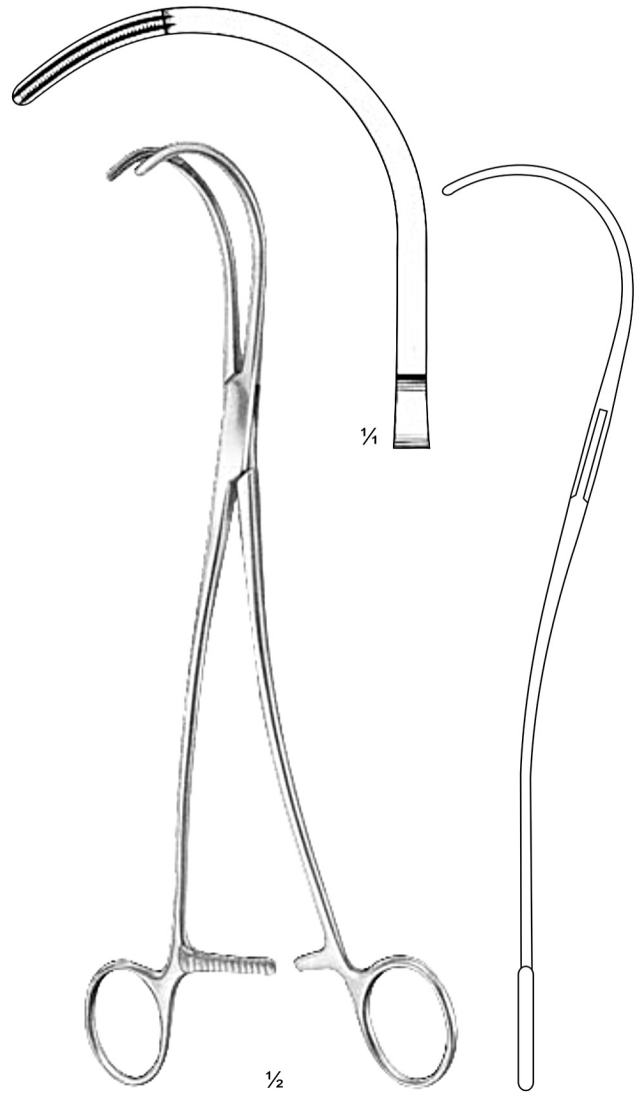

DeBakey
DC10-109-25
25 cm / 10"

Top view

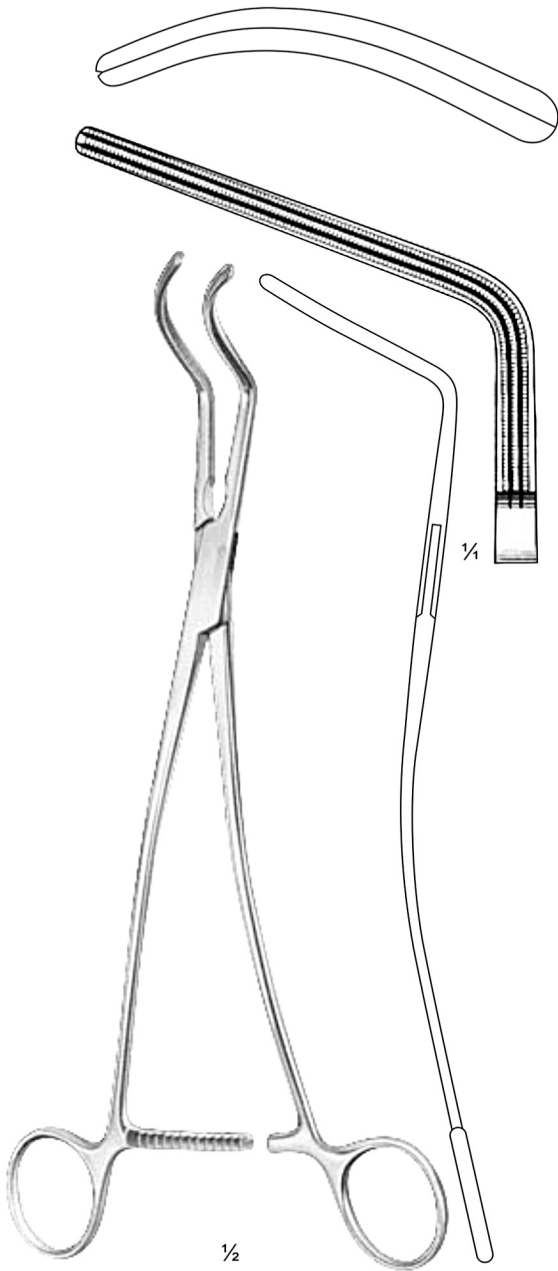

DeBakey
DC10-111-27
27 cm / 10 $\frac{1}{2}$ "

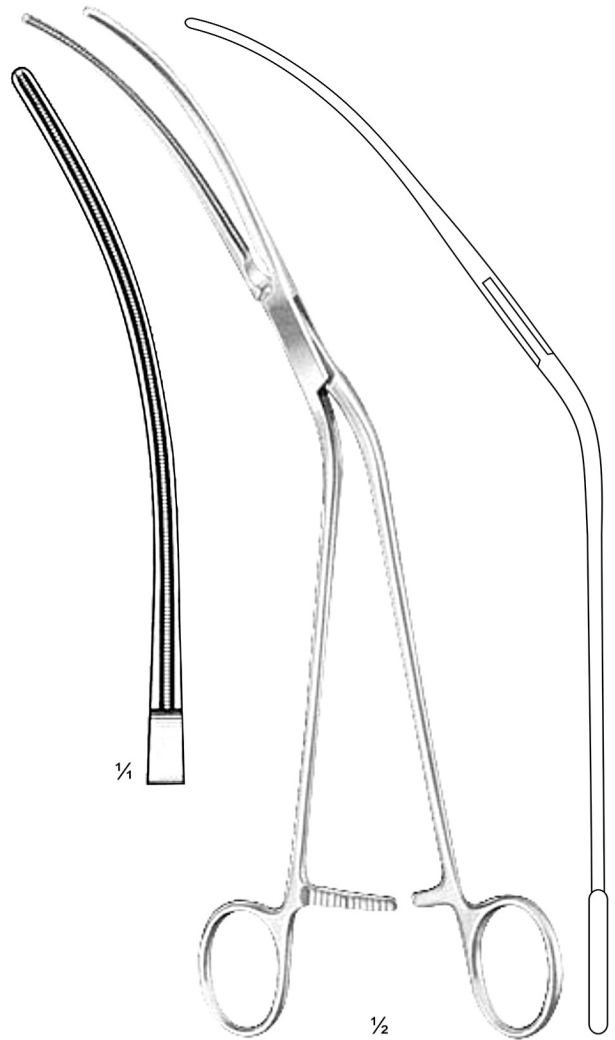

DeBakey
DC10-113-28
28 cm / 11"

Anastomosis Forceps



DeBakey-Glover

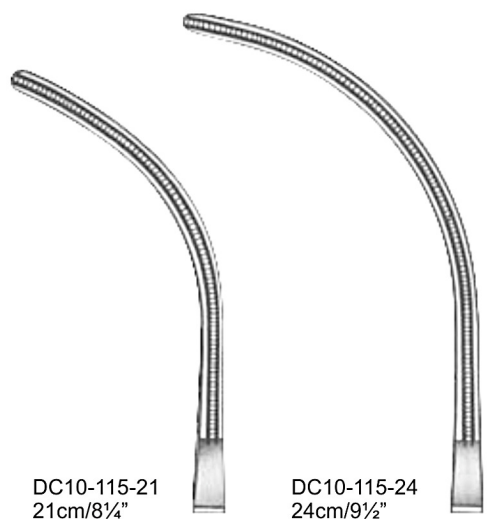

DC10-115-21
21cm/8¼"

DC10-115-24
24cm/9½"

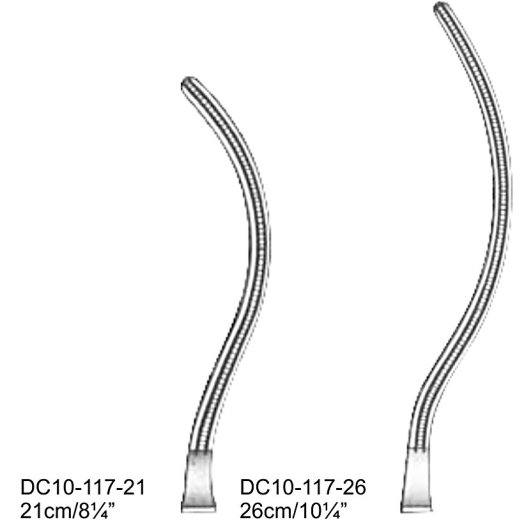

DC10-117-21
21cm/8¼"

DC10-117-26
26cm/10¼"

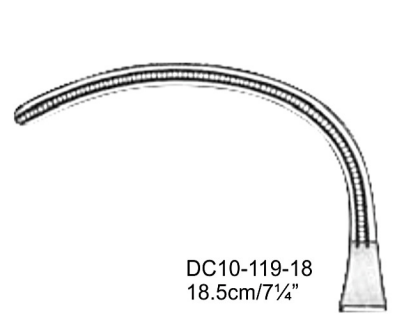

DC10-119-18
18.5cm/7¼"

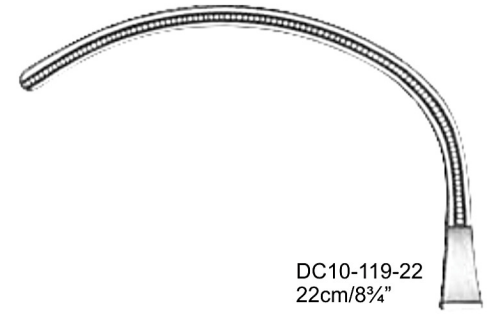

DC10-119-22
22cm/8¾"

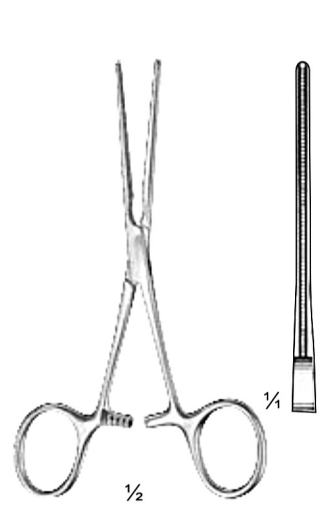

DeBakey
DC10-121-12
12 cm / 4 ¾"

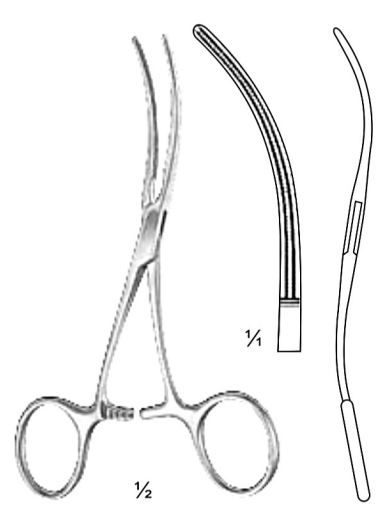

DeBakey
DC10-123-12
12 cm / 4 ¾"

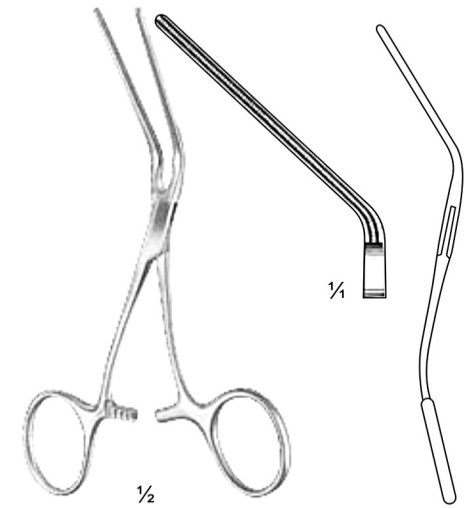

DeBakey
DC10-125-13
13 cm / 5 ¼"

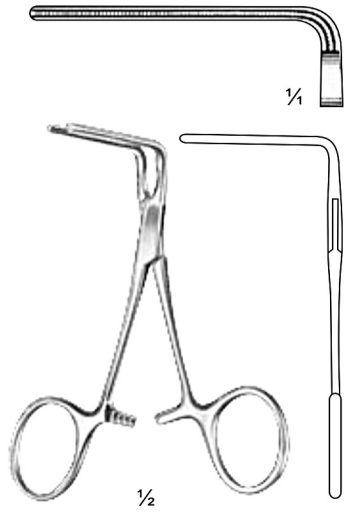

DeBakey
DC10-127-10
10 cm / 4"

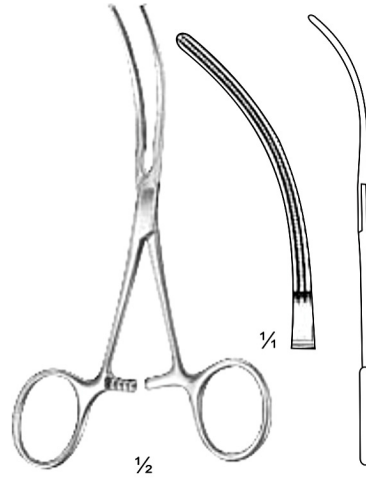

DeBakey
DC10-127-11
11 cm / 4 1/4"

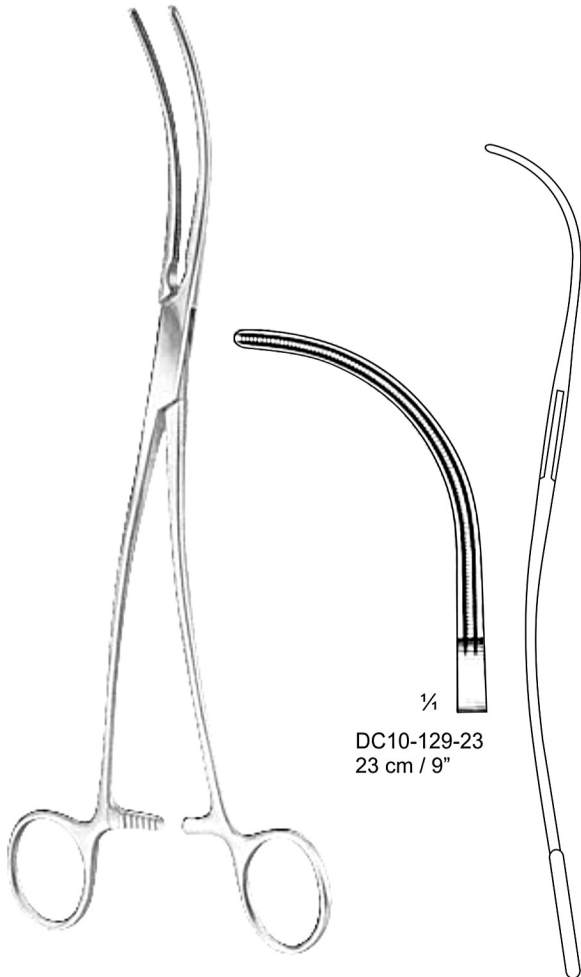

DC10-129-23
23 cm / 9"

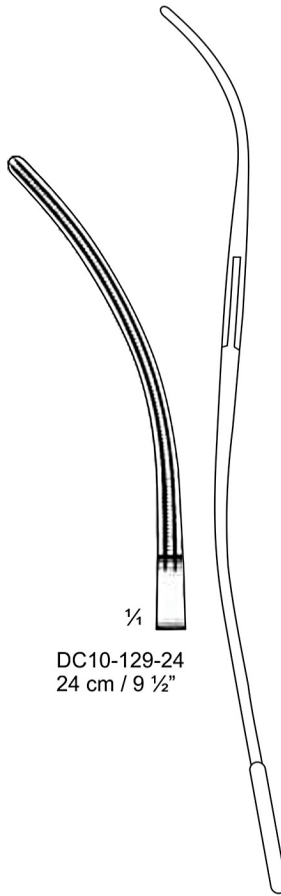

DC10-129-24
24 cm / 9 1/2"

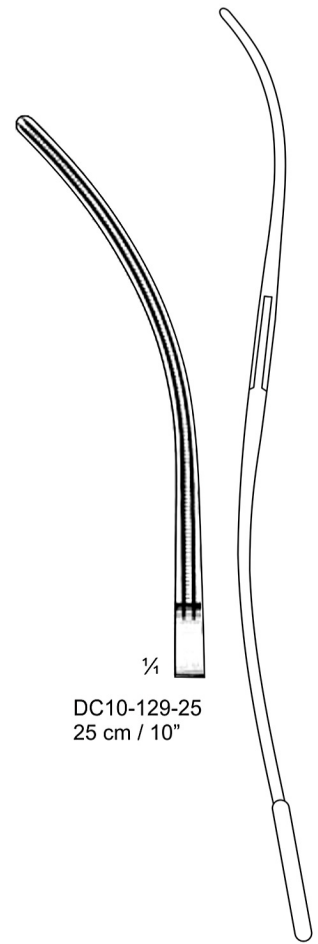

DC10-129-25
25 cm / 10"

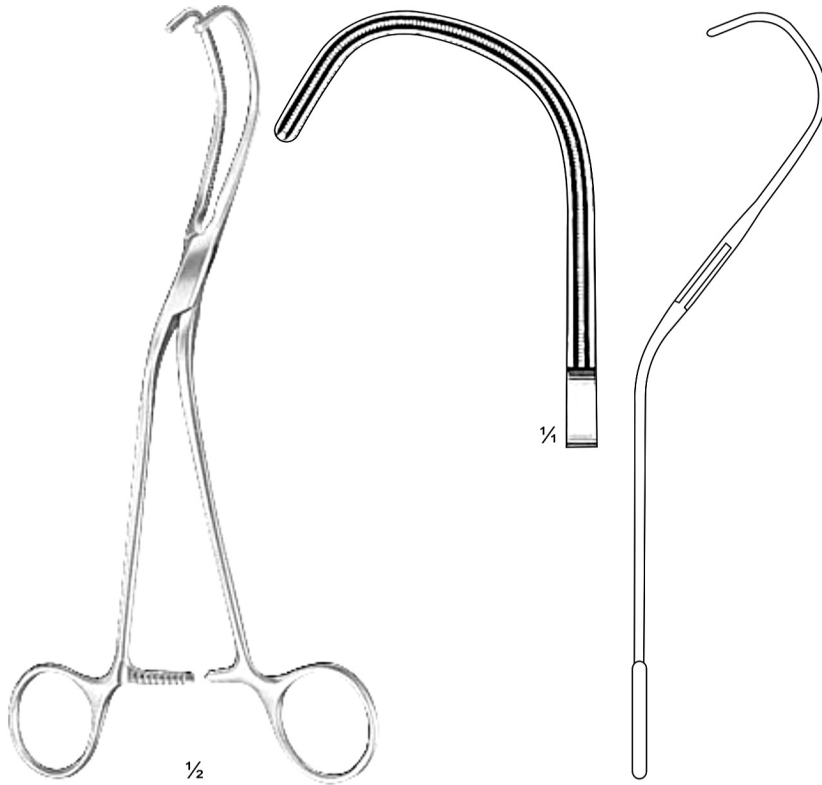

Lambert-Kay
DC10-131-21
21 cm / 8 1/4"

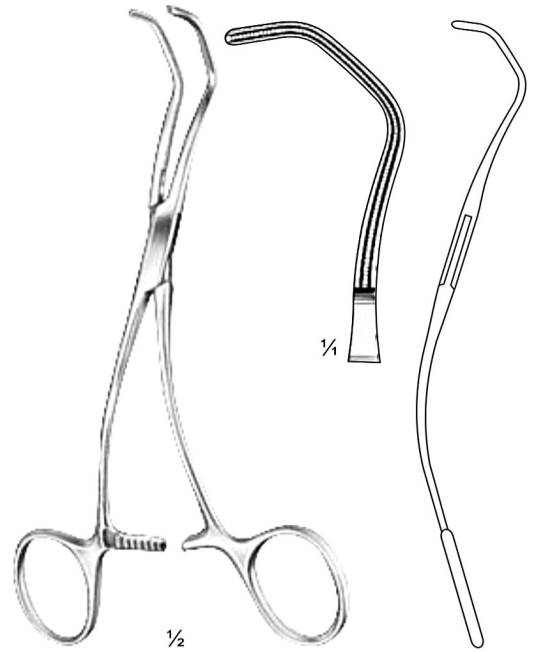

DeBakey
DC10-133-17
17 cm / 6 3/4"

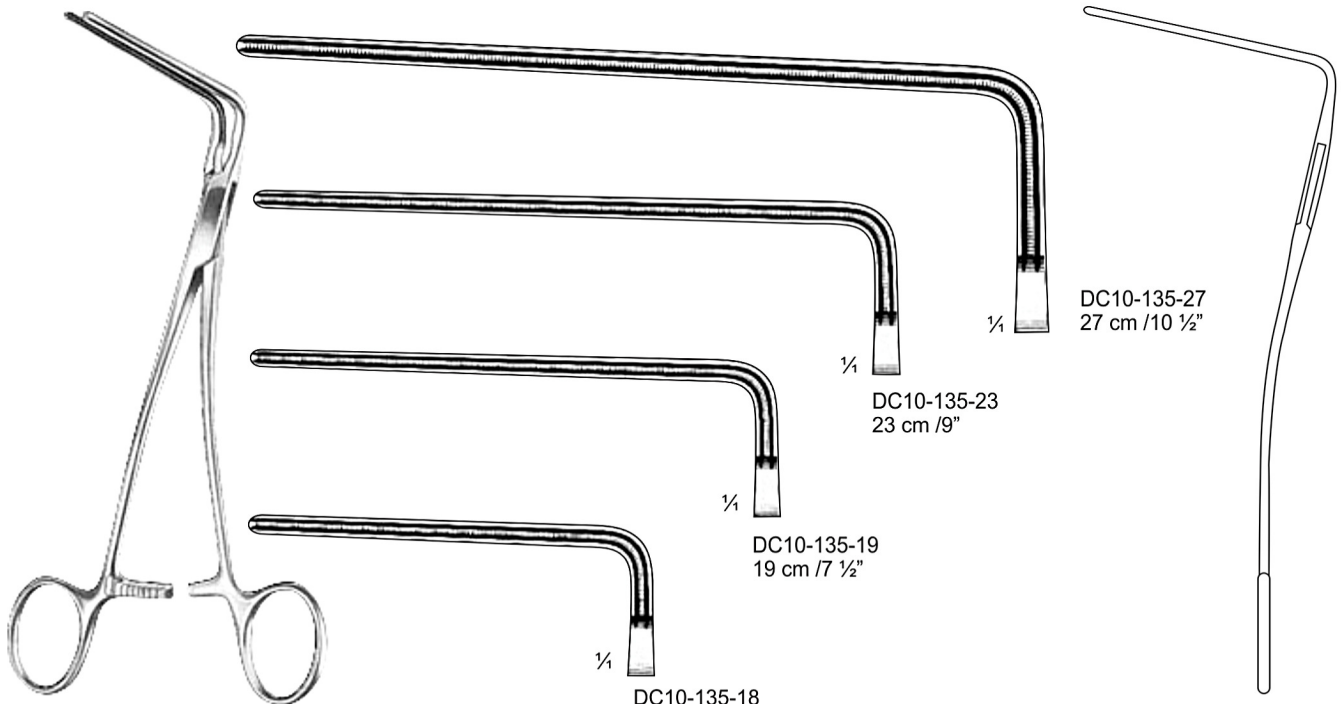

DeBakey
DC10-135-18 - DC10-135-27

DC10-135-18
18 cm / 7"

DC10-135-19
19 cm / 7 1/2"

DC10-135-23
23 cm / 9"

DC10-135-27
27 cm / 10 1/2"



DC10-137-20 - DC10-137-29

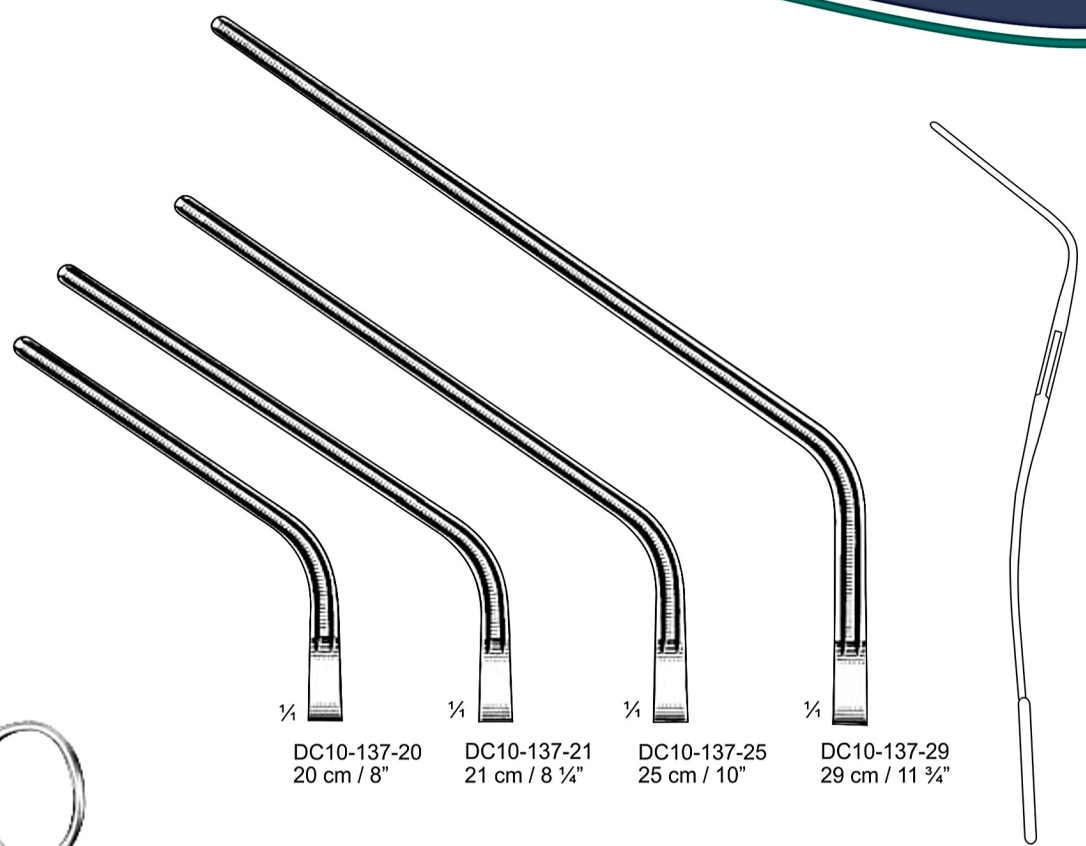

¼	¼	¼	¼
DC10-137-20 20 cm / 8"	DC10-137-21 21 cm / 8 ¼"	DC10-137-25 25 cm / 10"	DC10-137-29 29 cm / 11 ¼"



DeBakey

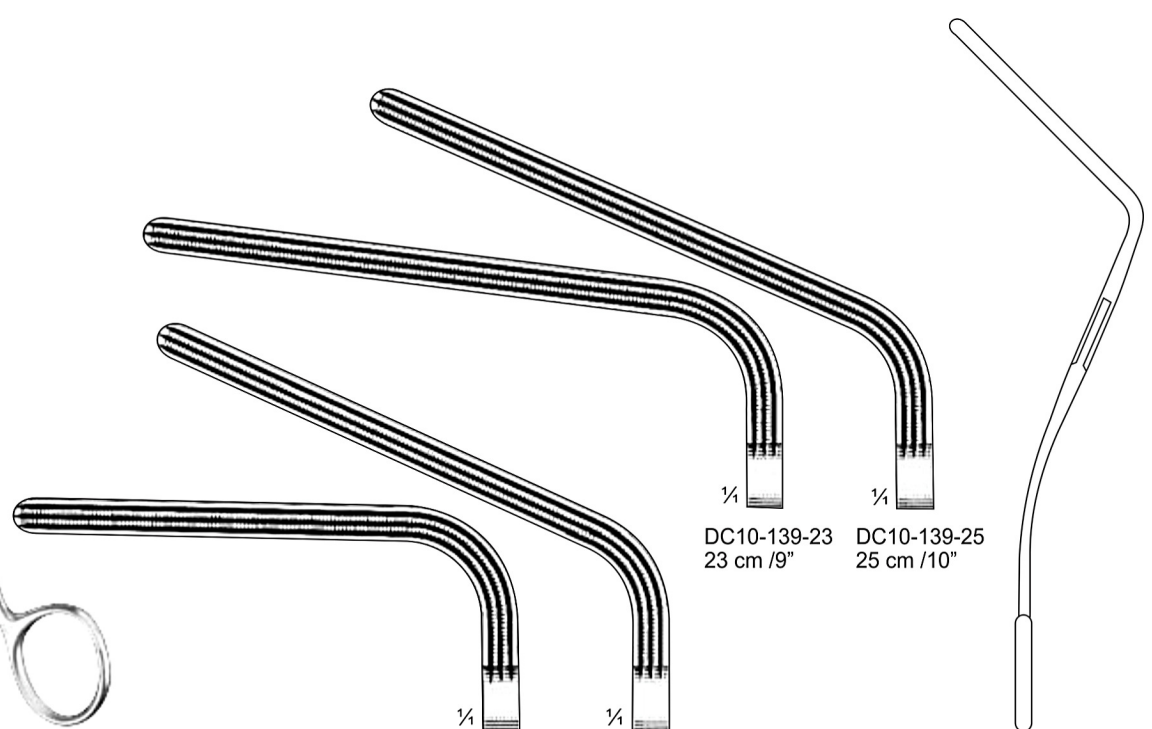

¼	¼	¼	¼
DC10-139-18 18 cm / 7"	DC10-139-20 20 cm / 8"	DC10-139-23 23 cm / 9"	DC10-139-25 25 cm / 10"

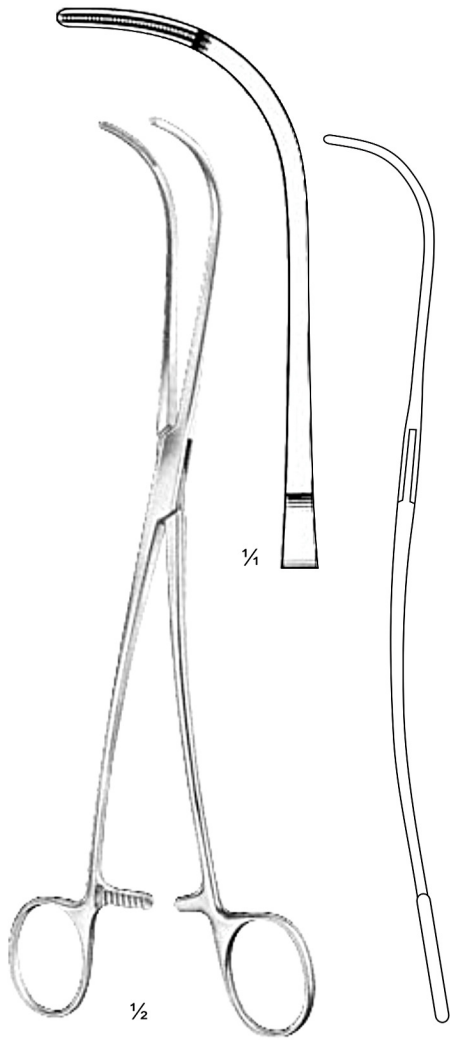

DeBakey
DC10-141-24
24 cm / 9 1/2"

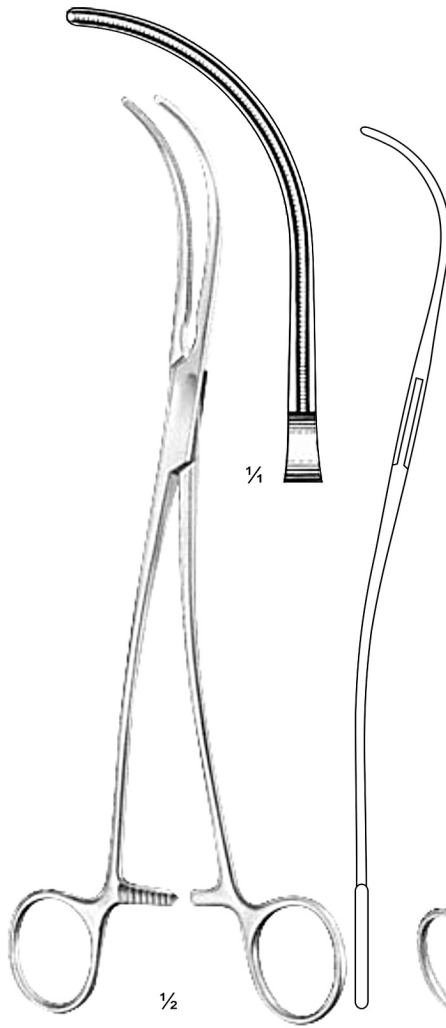

DC10-143-24
24 cm / 9 1/2"

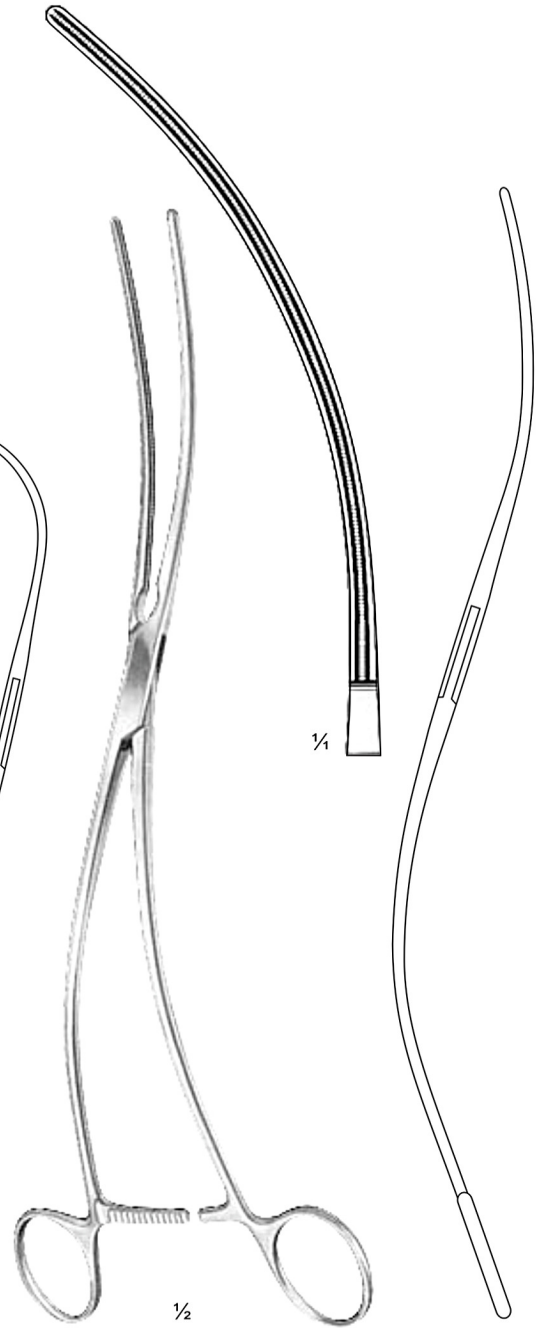

DC10-145-30
30 cm / 11 3/4"

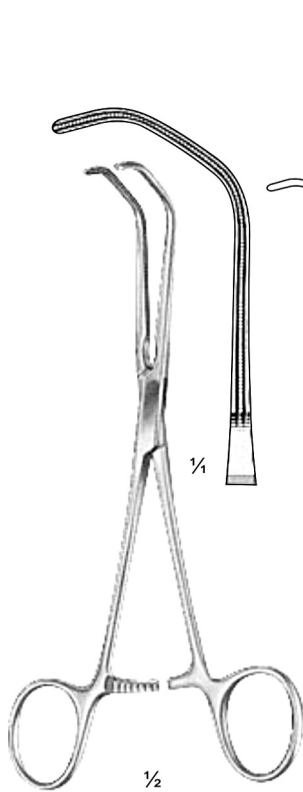

Beck
DC10-147-17
17 cm / 6 3/4"

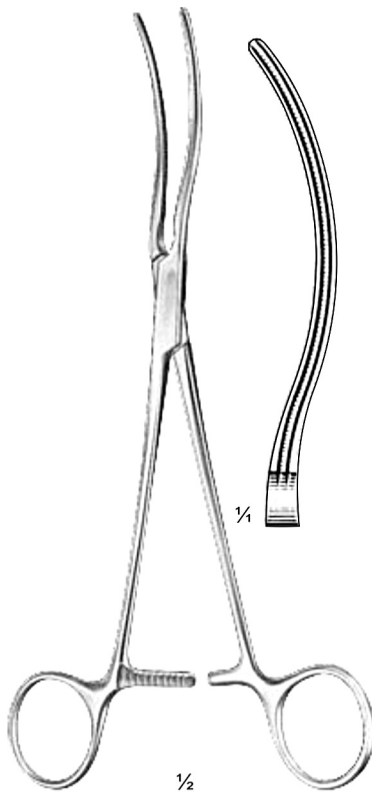

Potts
DC10-149-22
22 cm / 8 3/4"

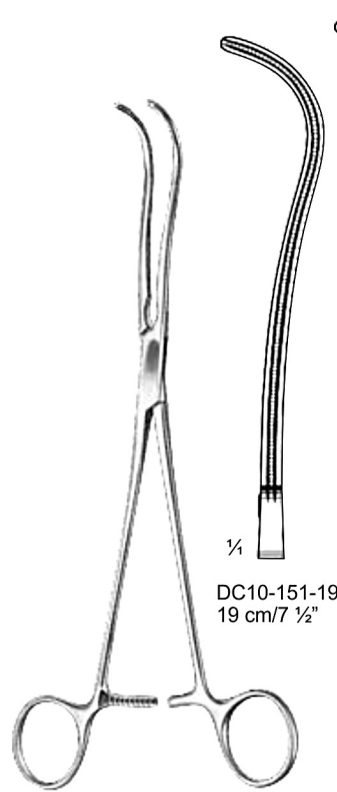

DC10-151-19
19 cm / 7 1/2"

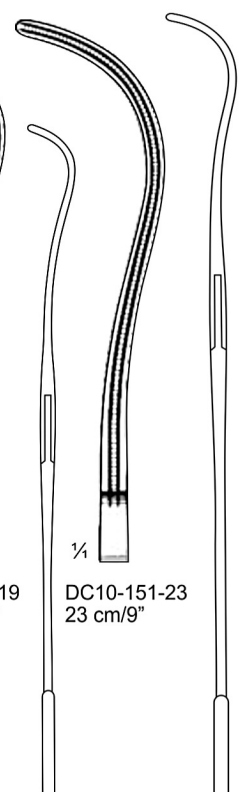

DC10-151-23
23 cm / 9"

DeBailey
DC10-151-19 - DC10-152-23

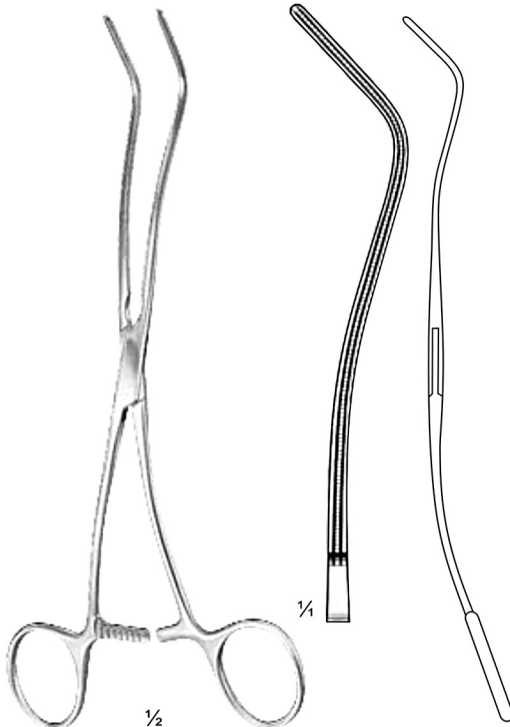

DeBailey
DC10-153-20
20 cm / 8"

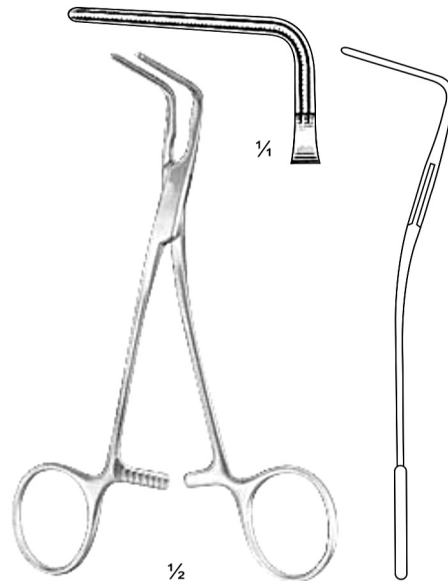

DeBailey
DC10-155-15
15 cm / 6"

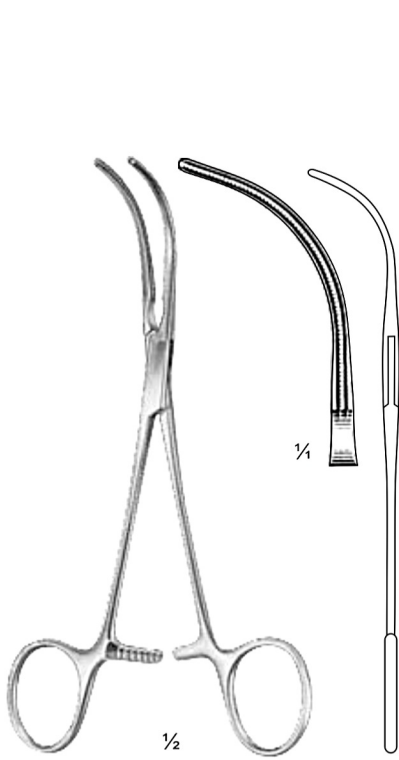

DeBakey
DC10-157-16
16 cm / 6 1/4"

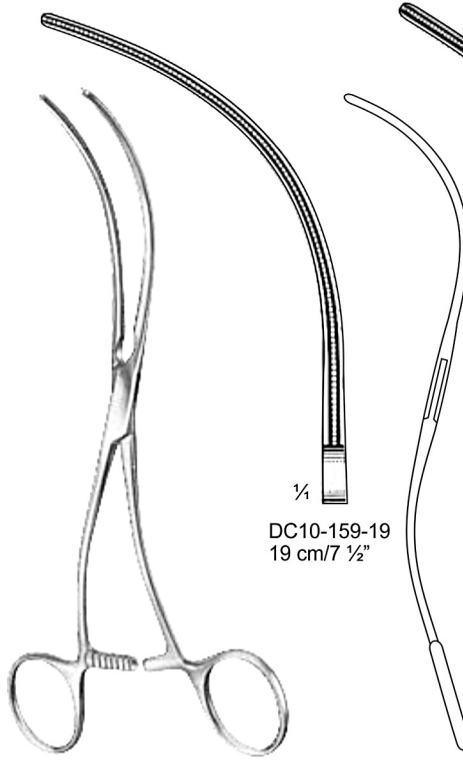

DC10-159-19
19 cm / 7 1/2"

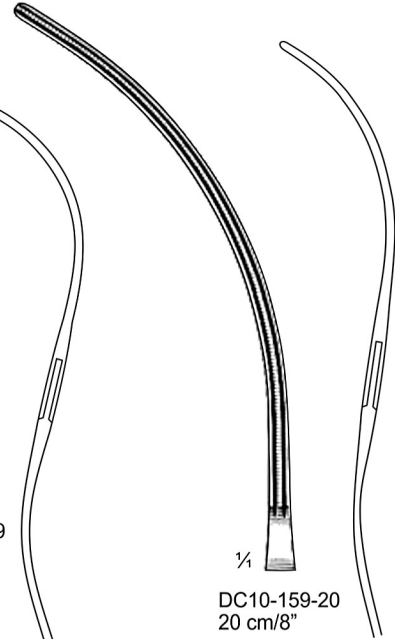

DC10-159-20
20 cm / 8"

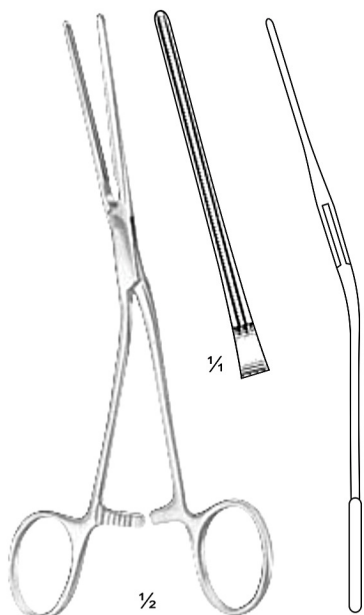

DeBakey
DC10-161-17
17 cm / 6 3/4"

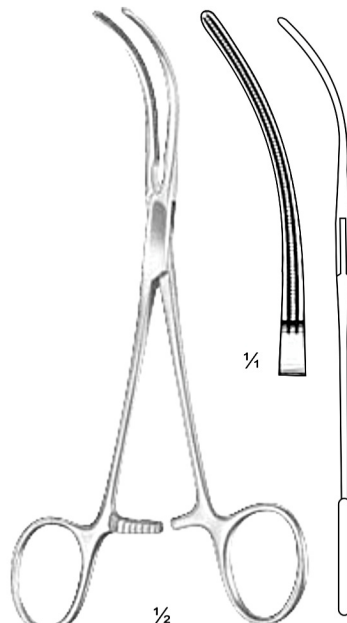

Glover
DC10-163-17
17 cm / 6 3/4"

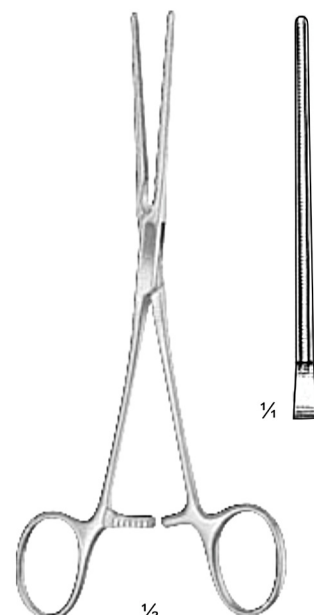

DeBakey
DC10-165-17
17 cm / 6 3/4"

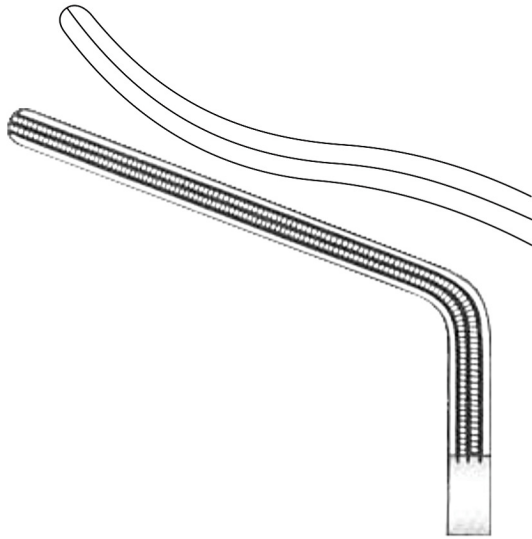

Aortic Forceps, angled, cup shaped jaw

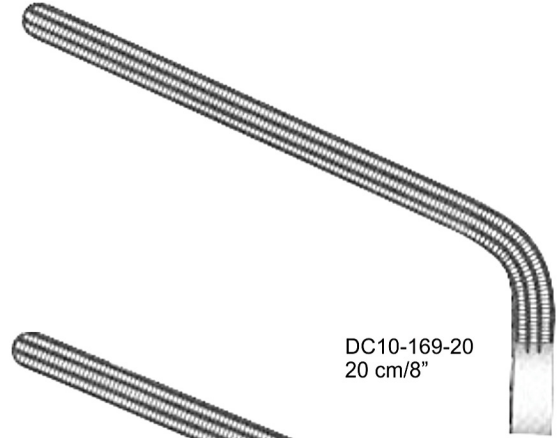

DC10-169-20
20 cm/8"

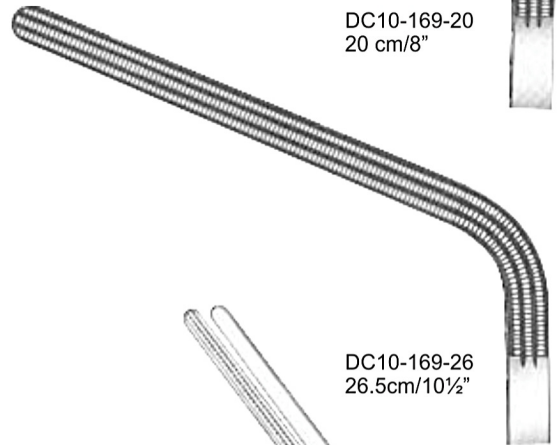

DC10-169-26
26.5cm/10½"

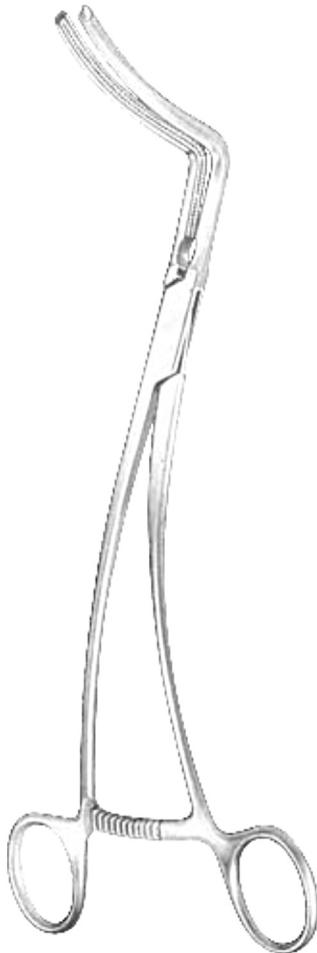

DeBakey
DC10-167-27
27cm/10¼"



DeBakey-Morris

Tangential Occlusion Forceps

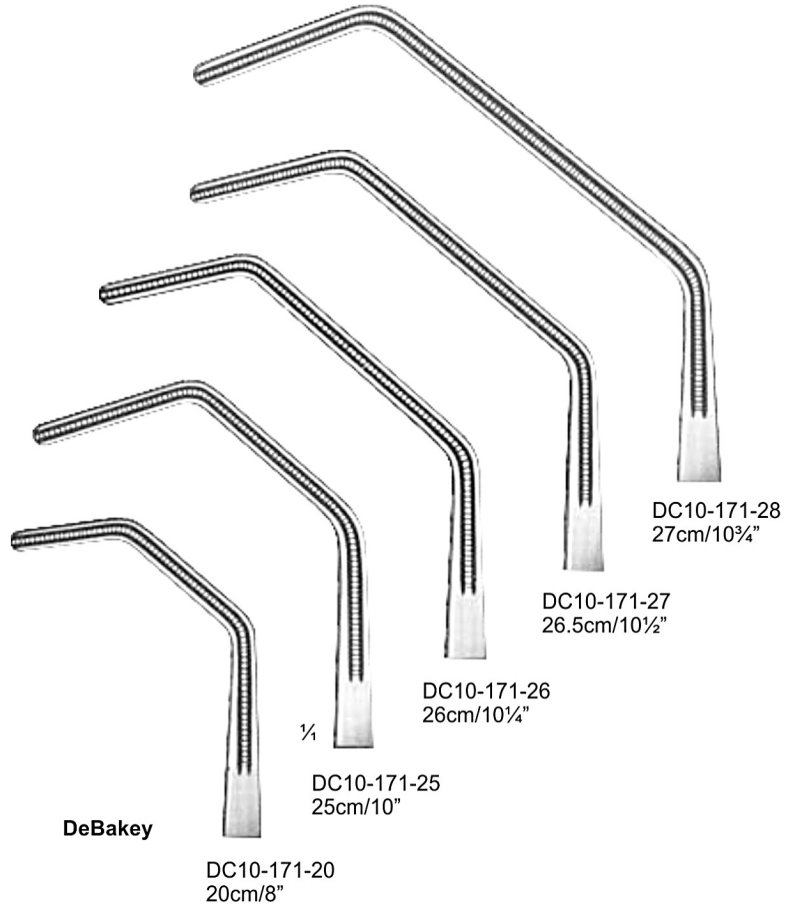
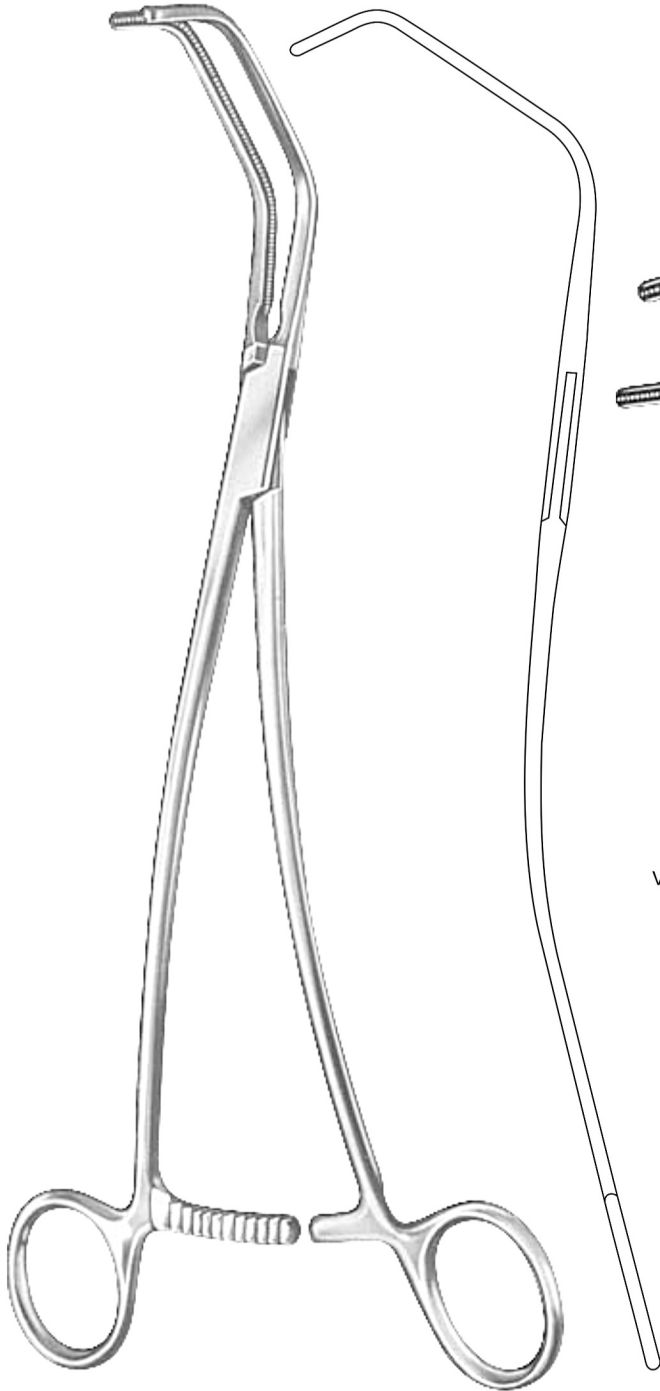

DeBakey

Vena cave Clamps



DeBakey-Satinsky

Also Patent
Ductus Forceps

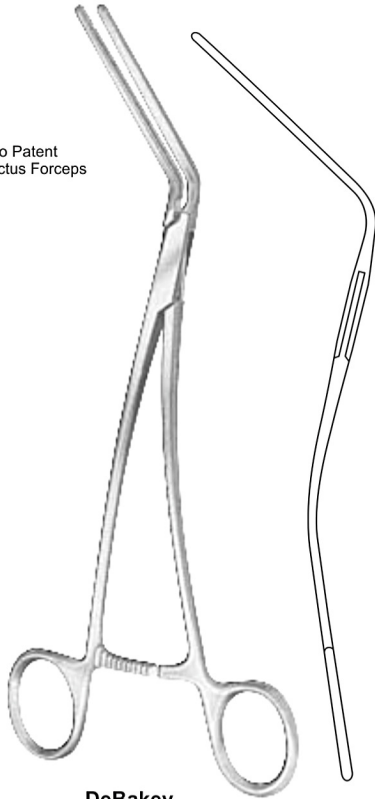

DeBakey

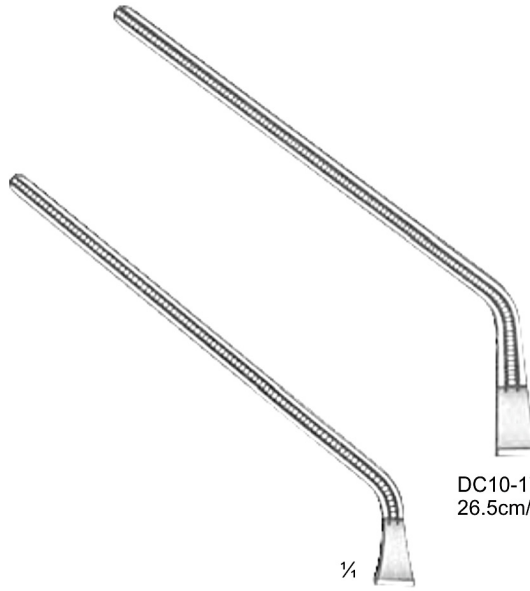

DC10-175-26
26.5cm/10½"

DC10-175-19
19cm/7½"

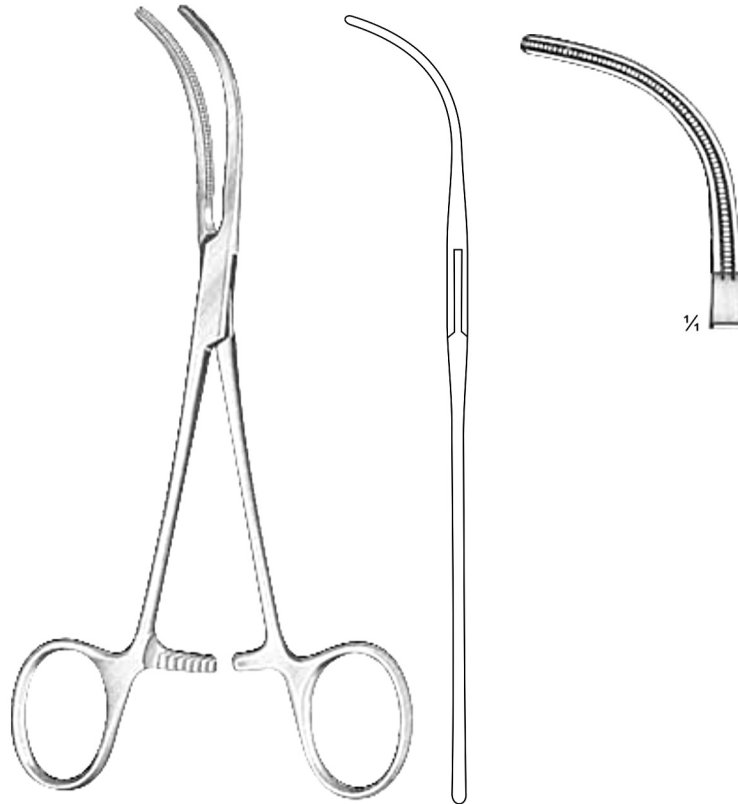

DeBakey
DC10-177-16
16cm/6¼"

INTERNATIONAL CRIMSON

Anastomosis Forceps

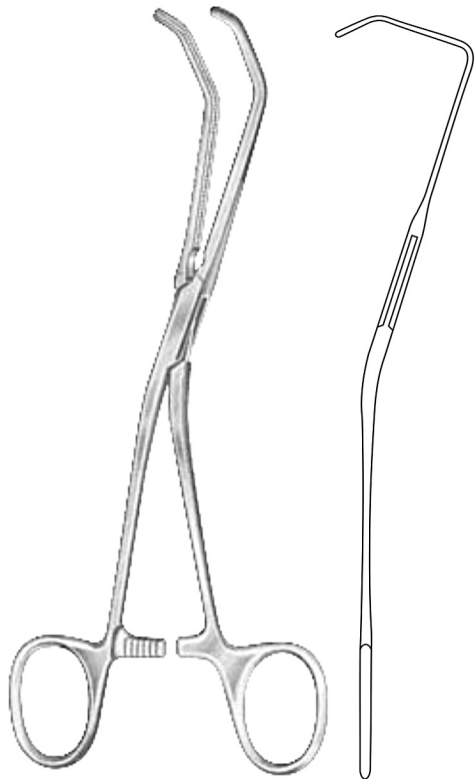
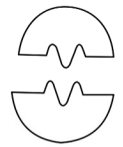

DeBakey-Reynolds

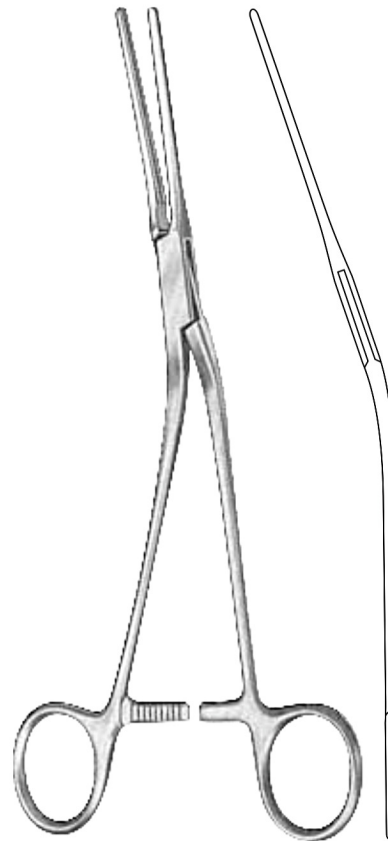

DeBakey

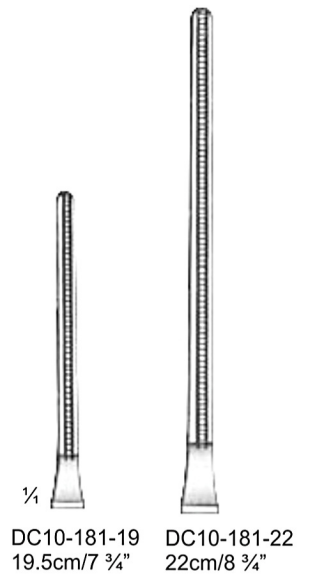

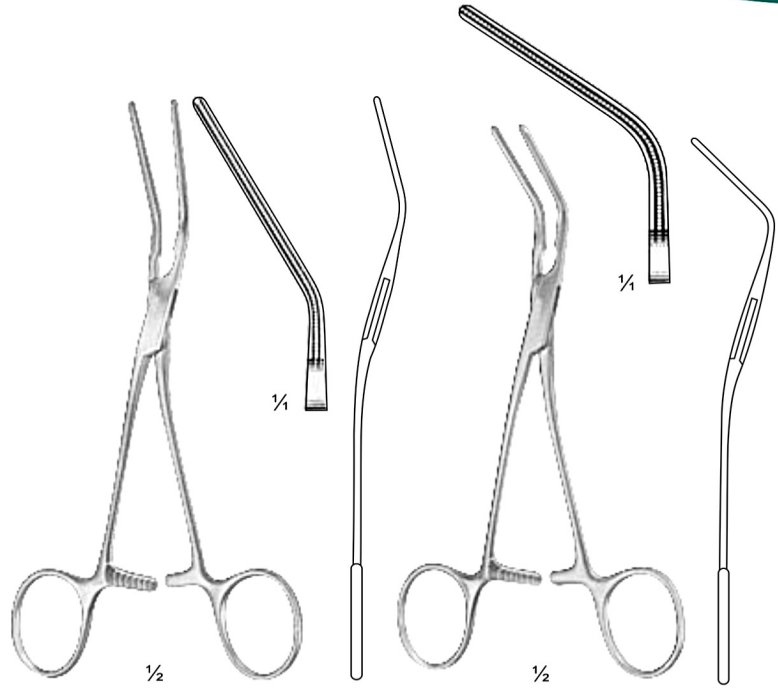
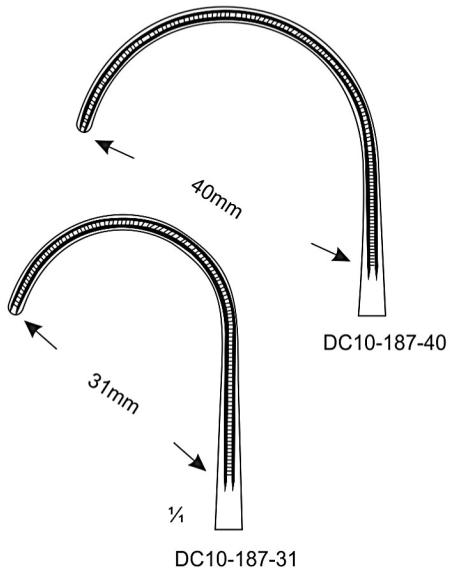

DeBakey
DC10-183-16
16 cm / 6 1/4"

DeBakey
DC10-185-15
15 cm / 6"

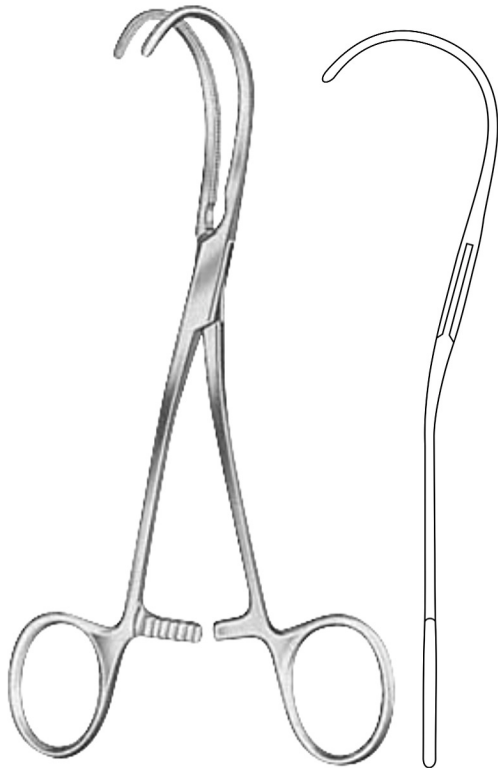

DeBakey

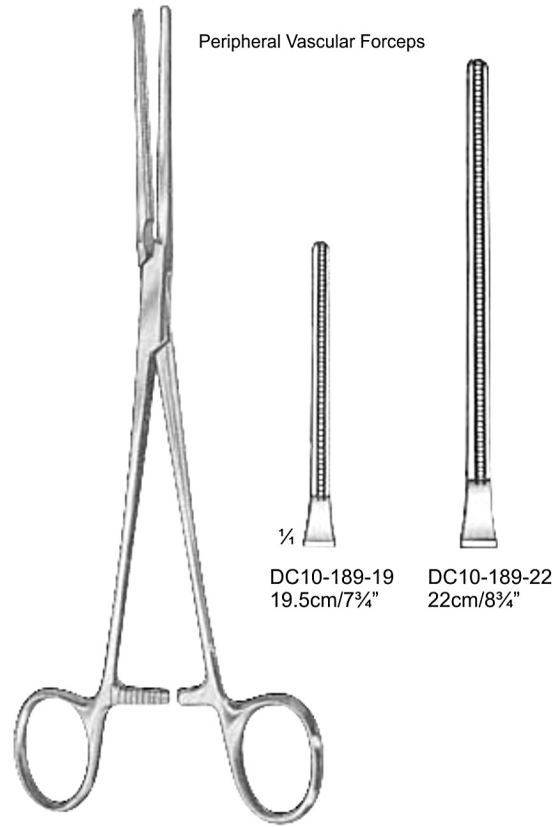

DeBakey



DeBakey-Bahnson

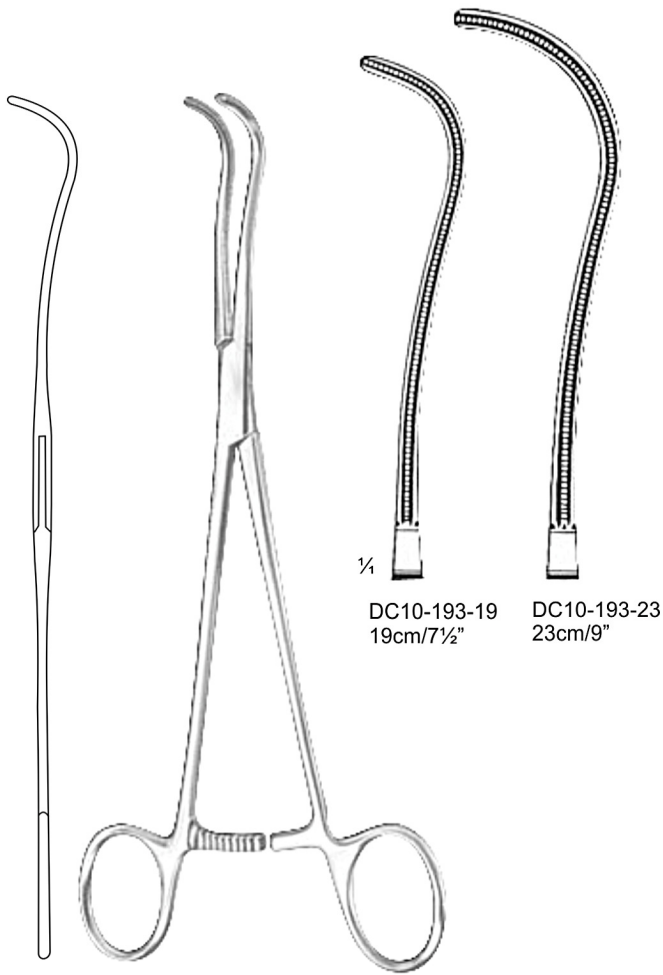

DeBakey

DC10-193-19
19cm/7½"

DC10-193-23
23cm/9"

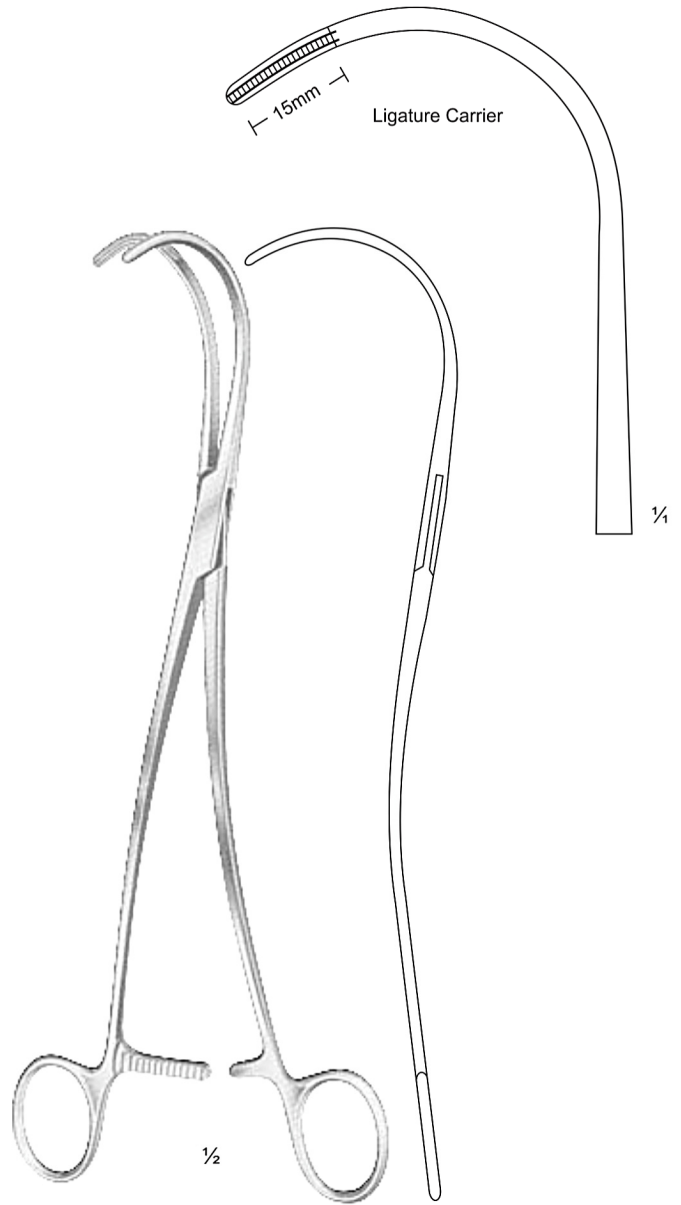

DeBakey-Semb
DC10-195-25
25cm/10"

15mm
Ligature Carrier

¼

½

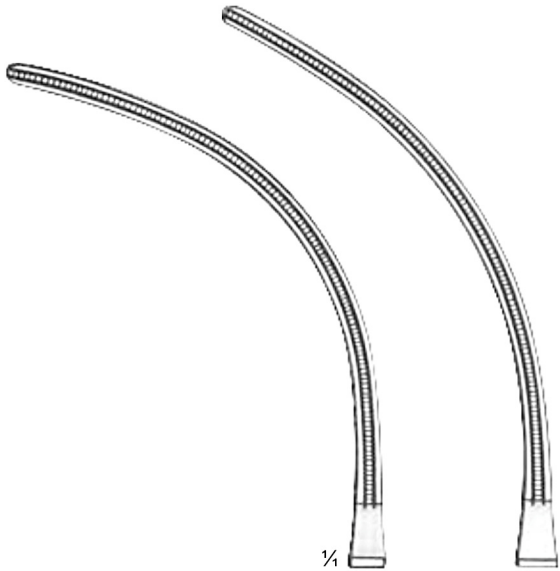

¼

DC10-197-19
19cm/7½"

DC10-197-20
20cm/8"

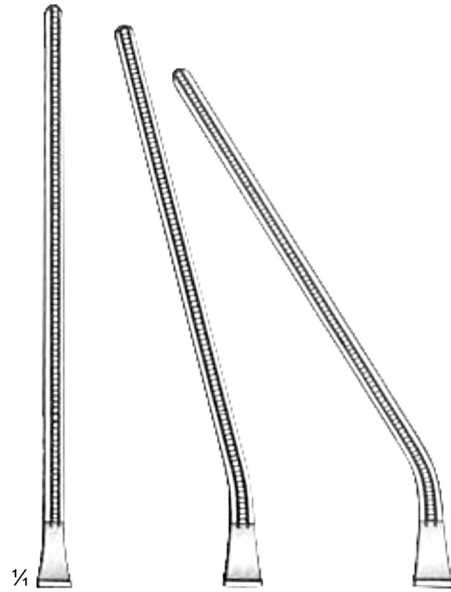

¼

DC10-199-19
19.5cm/7¾"

DC10-201-20
19.5cm/7¾"

DC10-203-19
19.5cm/7¾"

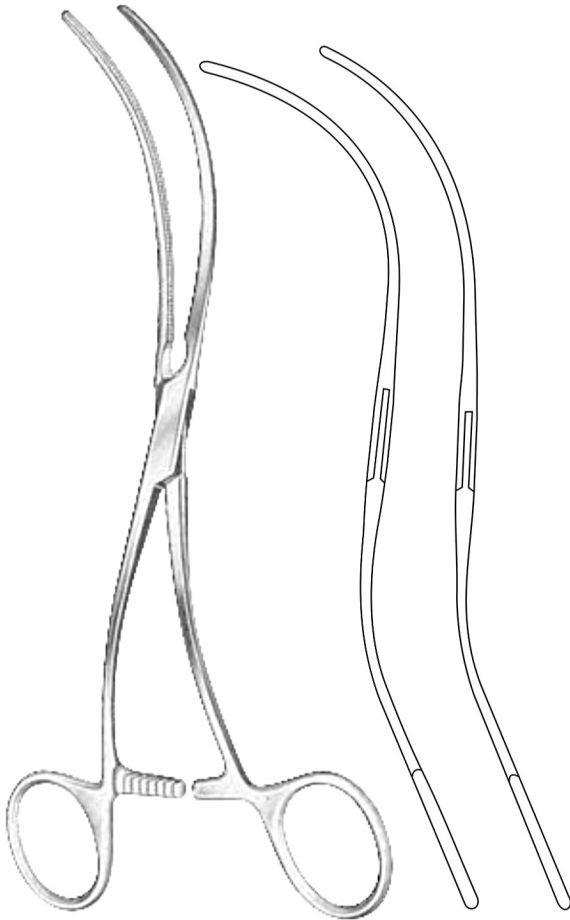

DeBakey

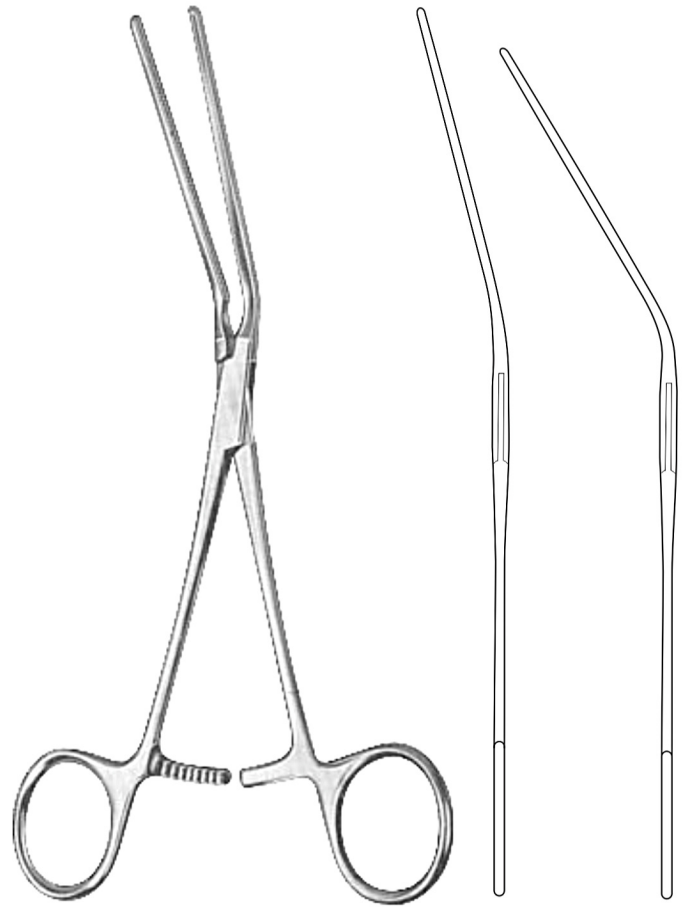

Leland-Jones

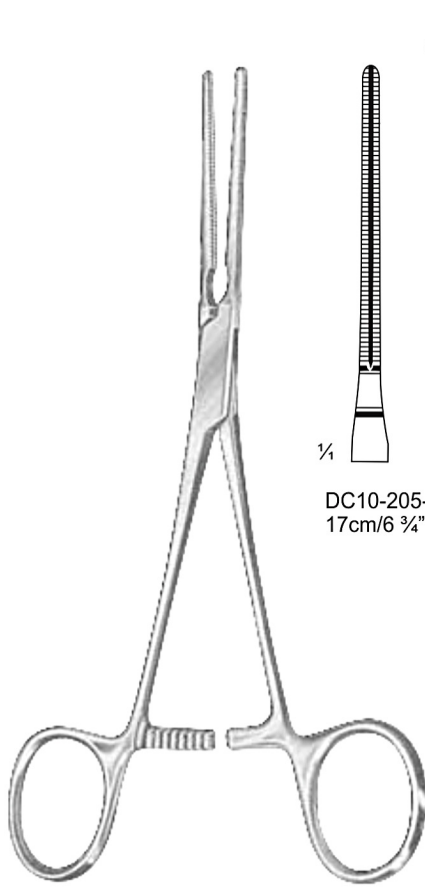

Cooley

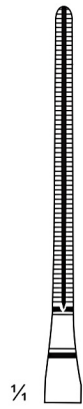

DC10-205-17
17cm/6 3/4"

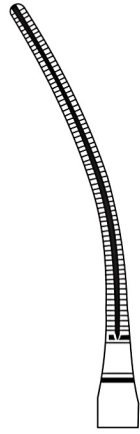

DC10-207-17
17.5cm/7"



DC10-209-18
18cm/7"

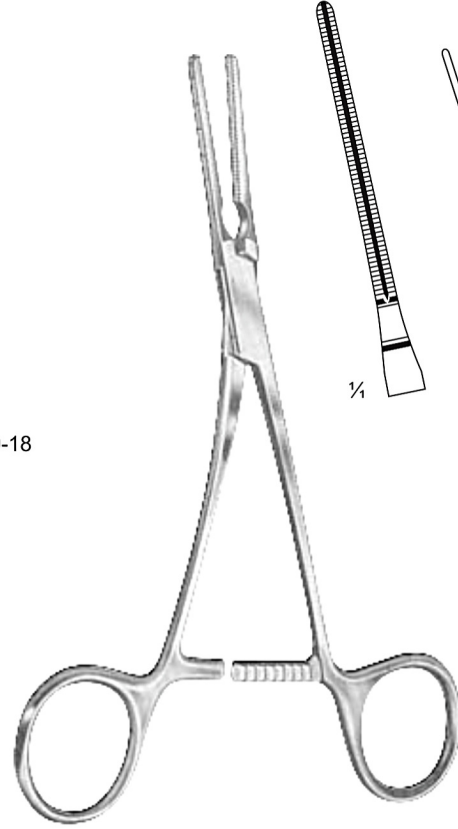

Cooley
DC10-211-17
17cm/6 3/4"

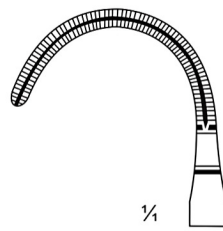
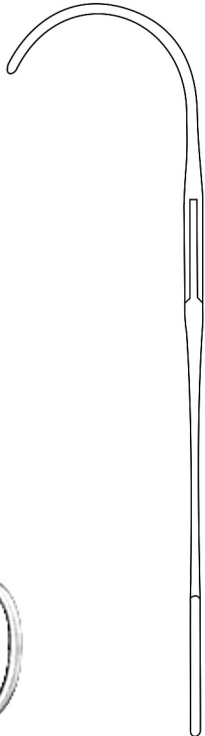
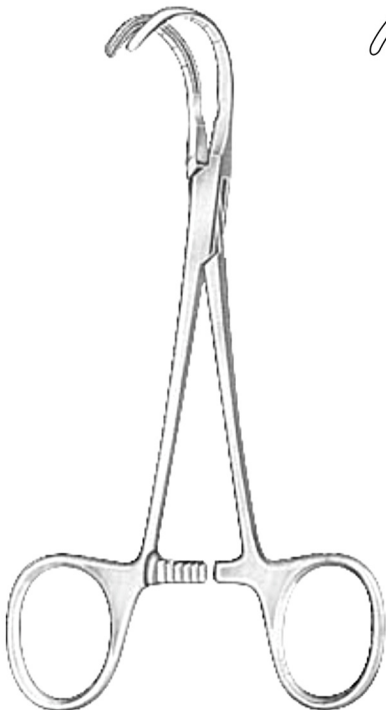
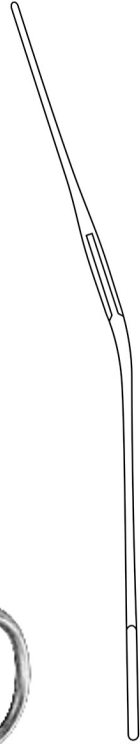

DC10-213-15
15cm/6"

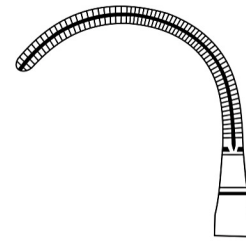

DC10-213-16
15.5cm/6"

Vascular Clamps

Multi Purpose Forceps



Cooley

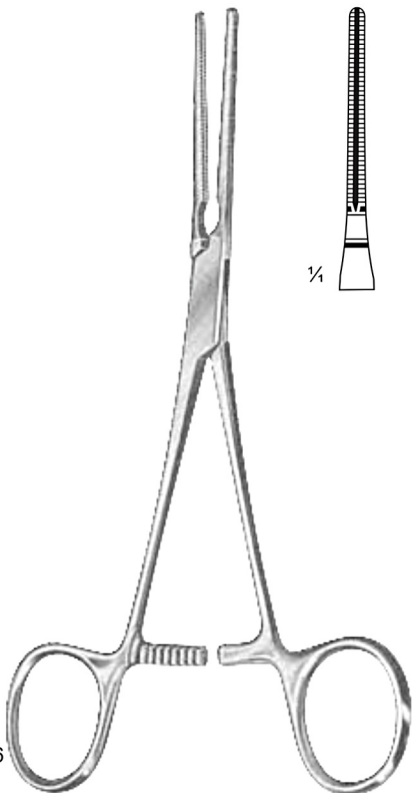
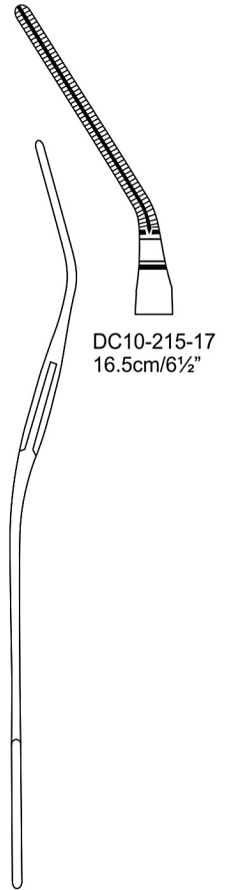
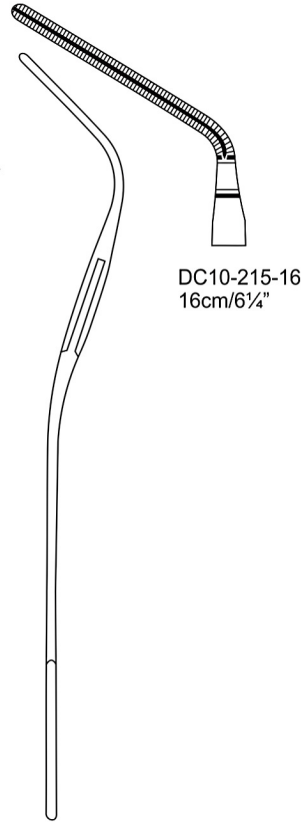
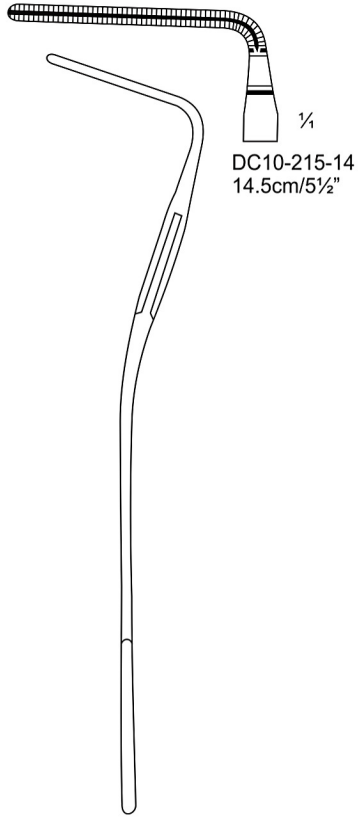

Cooley
DC10-217-16
16cm/6 1/4"

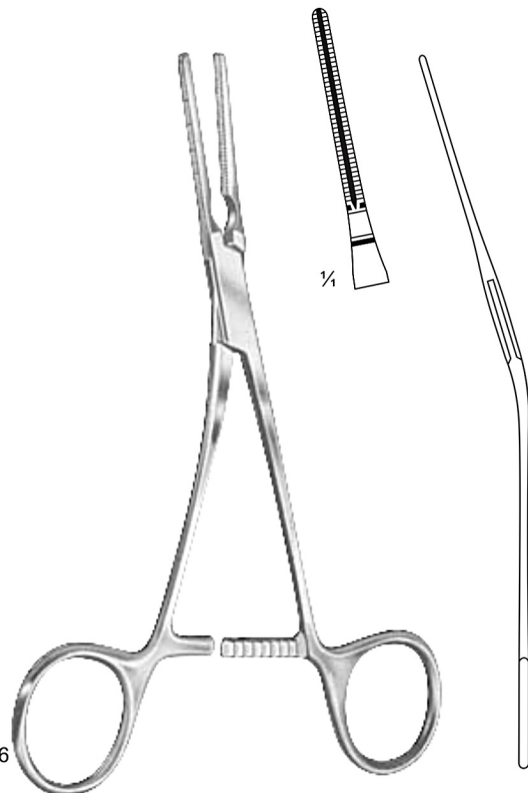
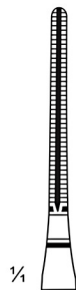

Cooley
DC10-219-16
16cm/6 1/4"



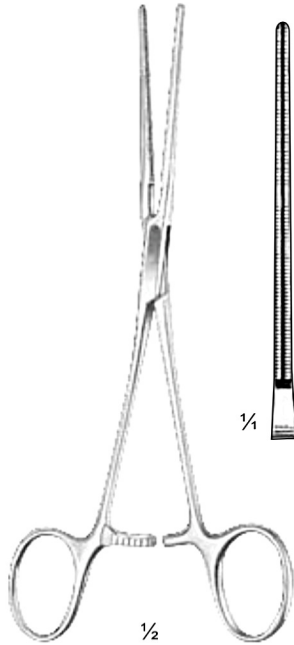

Cooley
DC10-221-17
17 cm / 6 3/4"

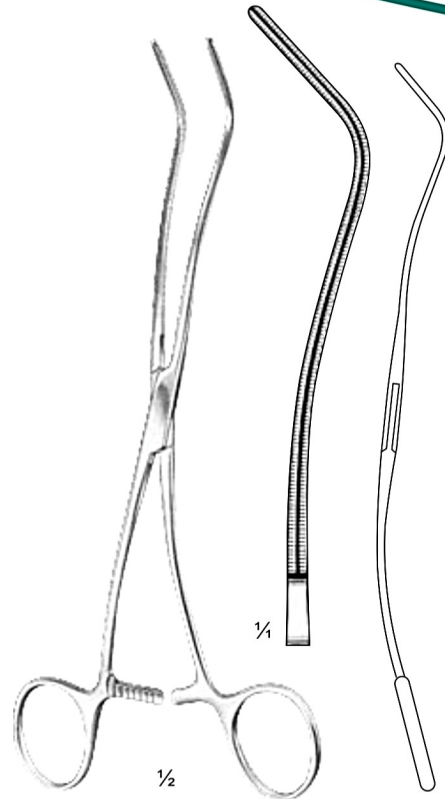

Cooley
DC10-223-20
20 cm / 8"

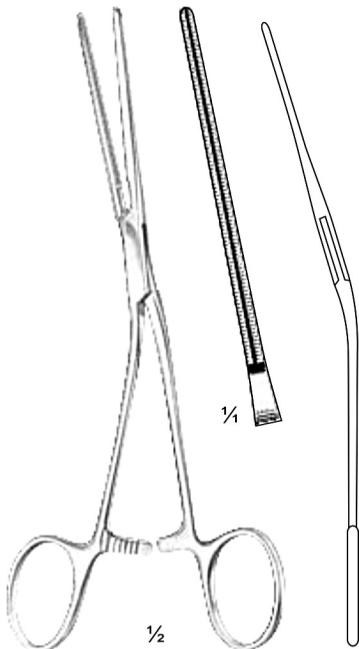

Cooley
DC10-225-17
17 cm / 6 3/4"

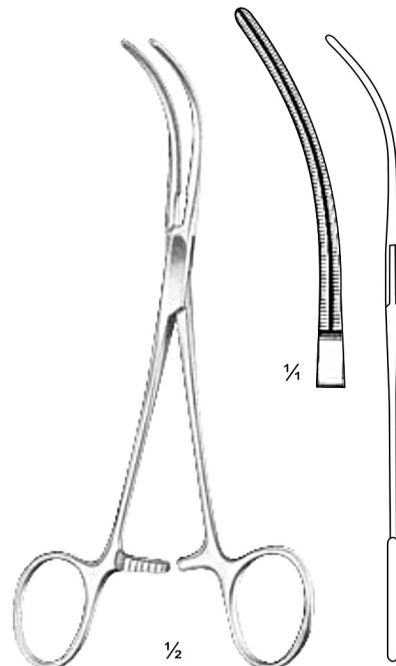

Cooley
DC10-227-17
17 cm / 6 3/4"

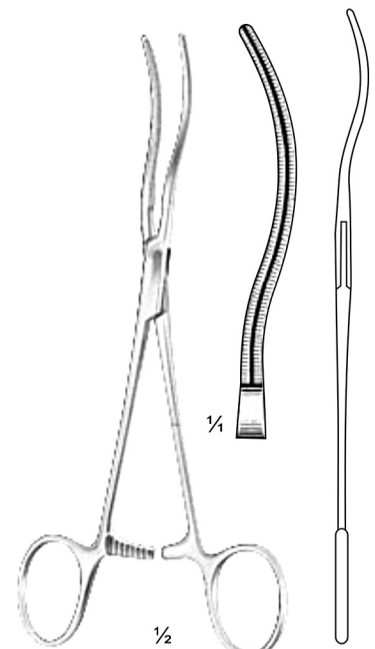

Cooley
DC10-229-17
17 cm / 6 3/4"

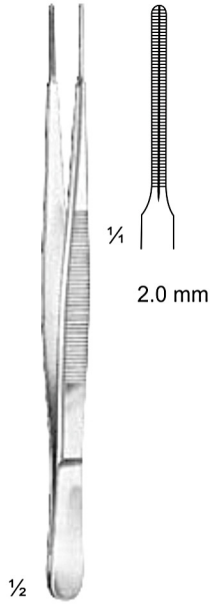

Cooley
DC10-231-16 = 16 cm / 6 1/4"
DC10-231-20 = 20 cm / 8"

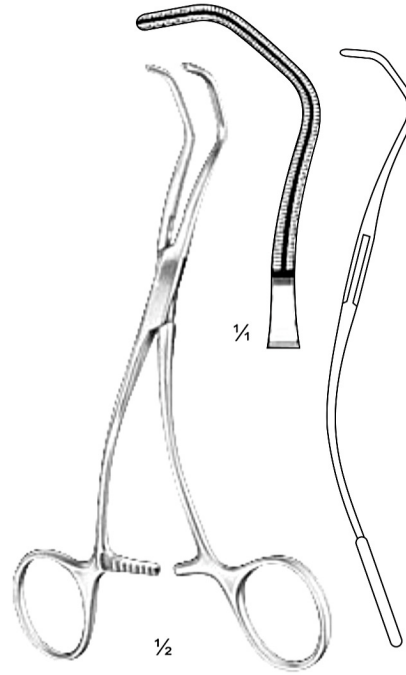

Cooley
DC10-233-16
16 cm / 6 1/4"

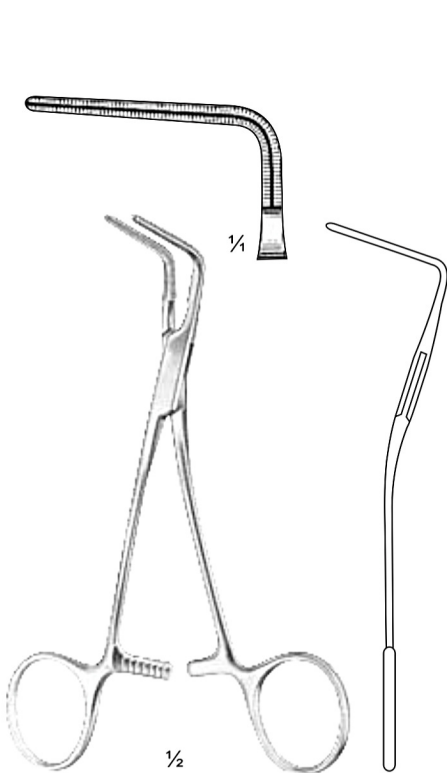

Cooley
DC10-235-15
15 cm / 6"

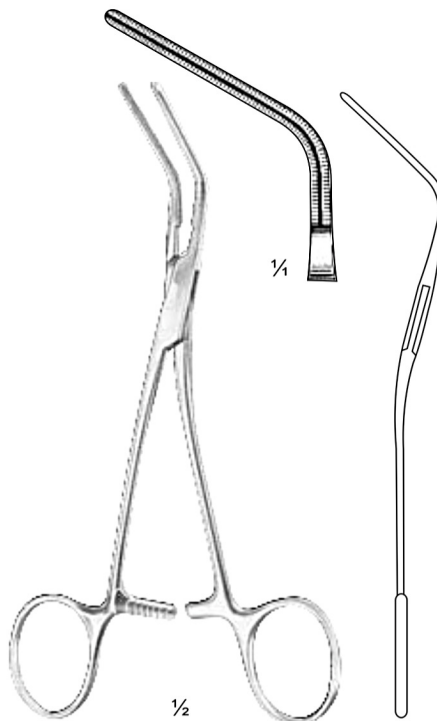

Cooley
DC10-235-16
15.5 cm / 6 1/8"

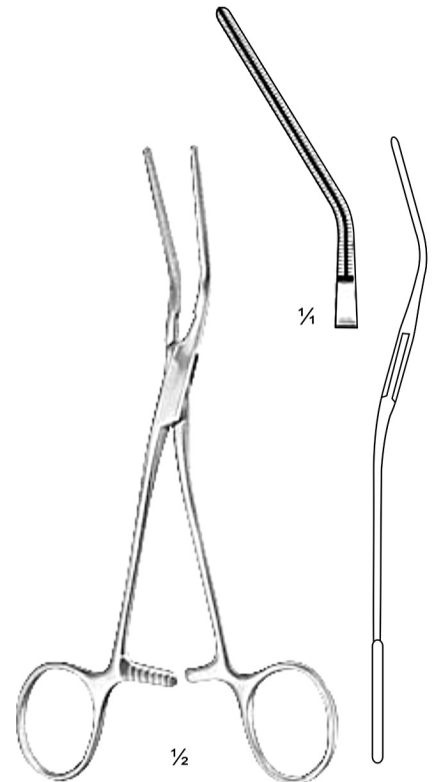

Cooley
DC10-235-17
17 cm / 6 3/4"

Anastomosis Forceps

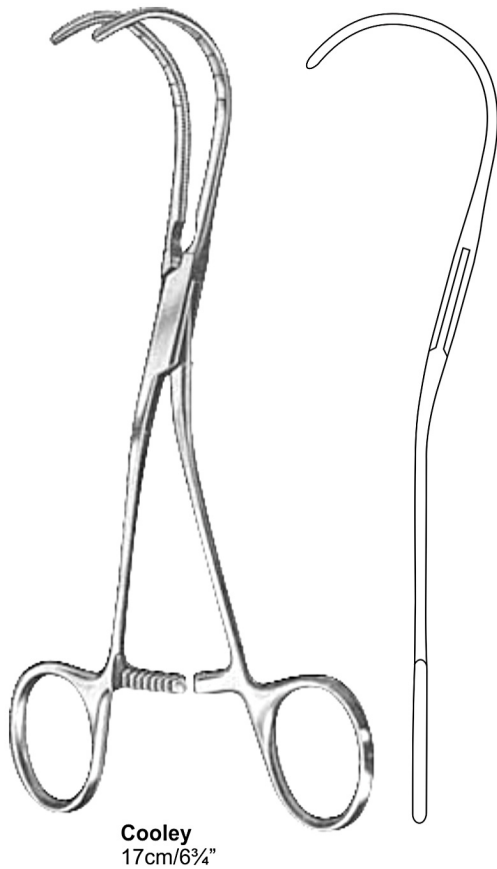
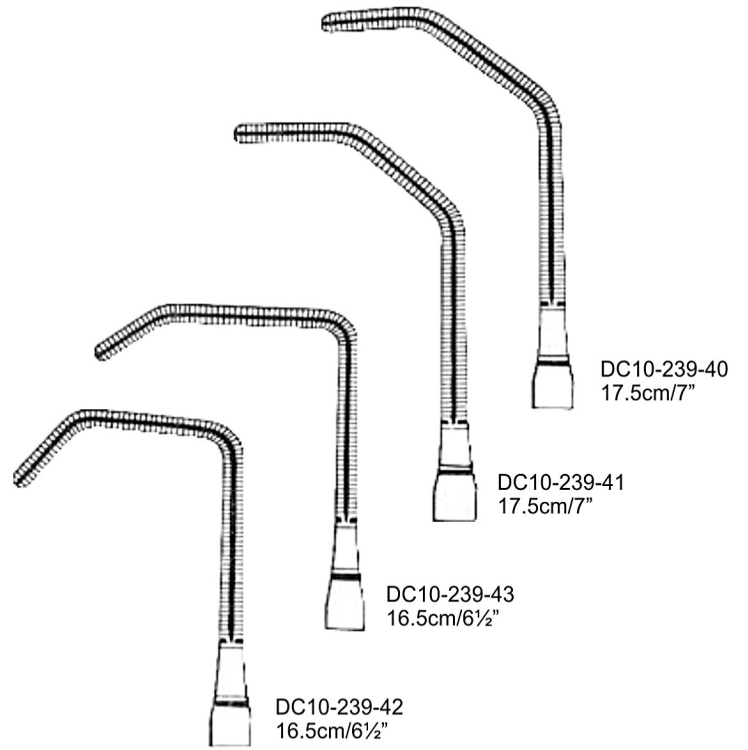
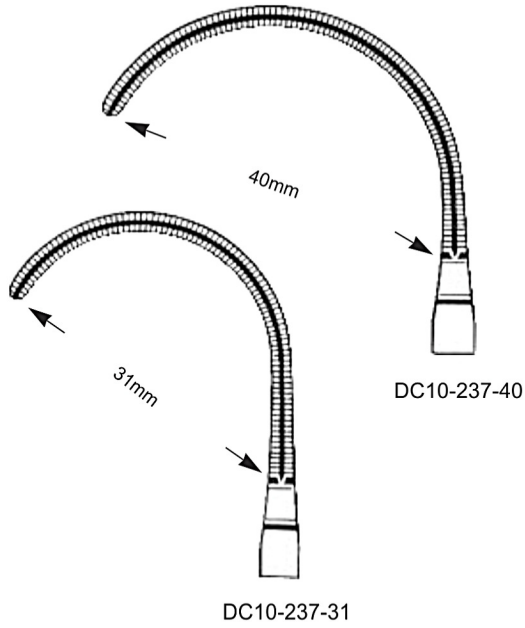

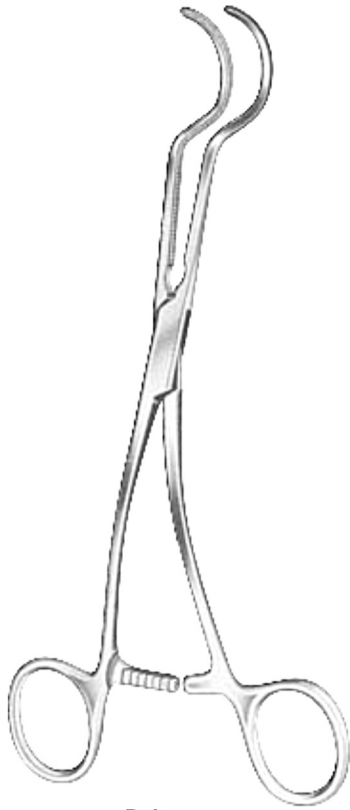

Dale

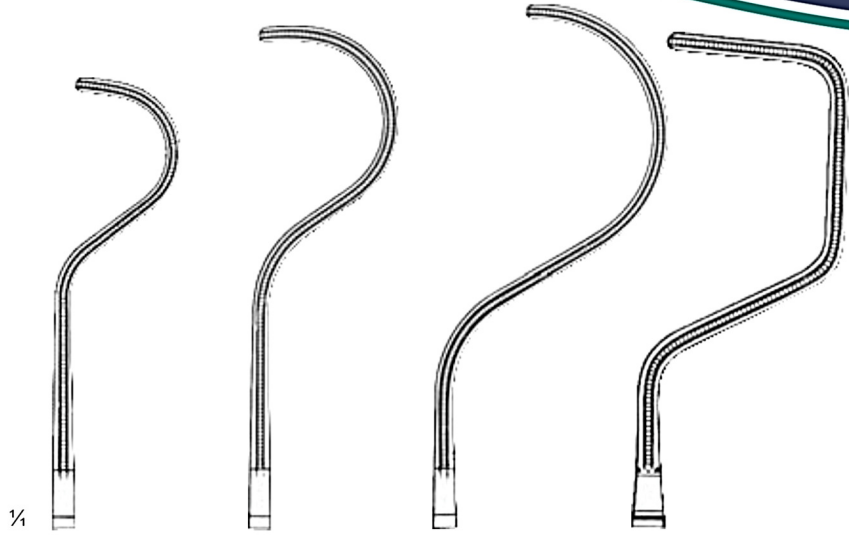

- DC10-241-17
17cm/6 3/4"
- DC10-241-18
17cm/6 3/4"
- DC10-241-19
18.5cm/7 1/4"
- DC10-243-18
18.5cm/7 1/4"

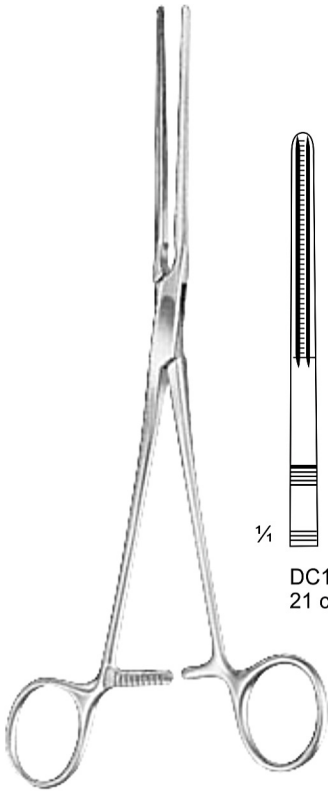

Potts

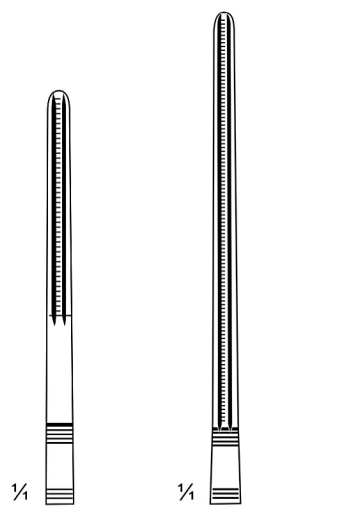

- DC10-245-21
21 cm/8 1/4"
- DC10-245-22
22 cm/8 3/4"

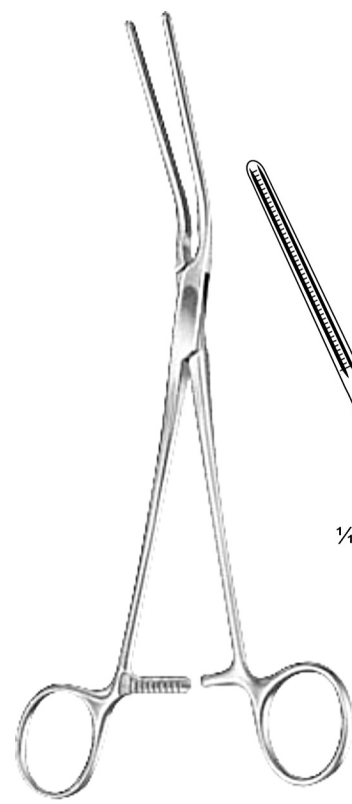

Potts

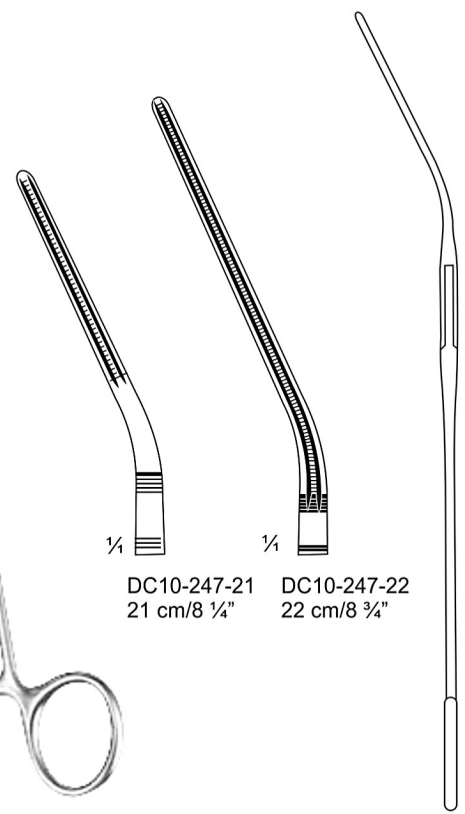

- DC10-247-21
21 cm/8 1/4"
- DC10-247-22
22 cm/8 3/4"

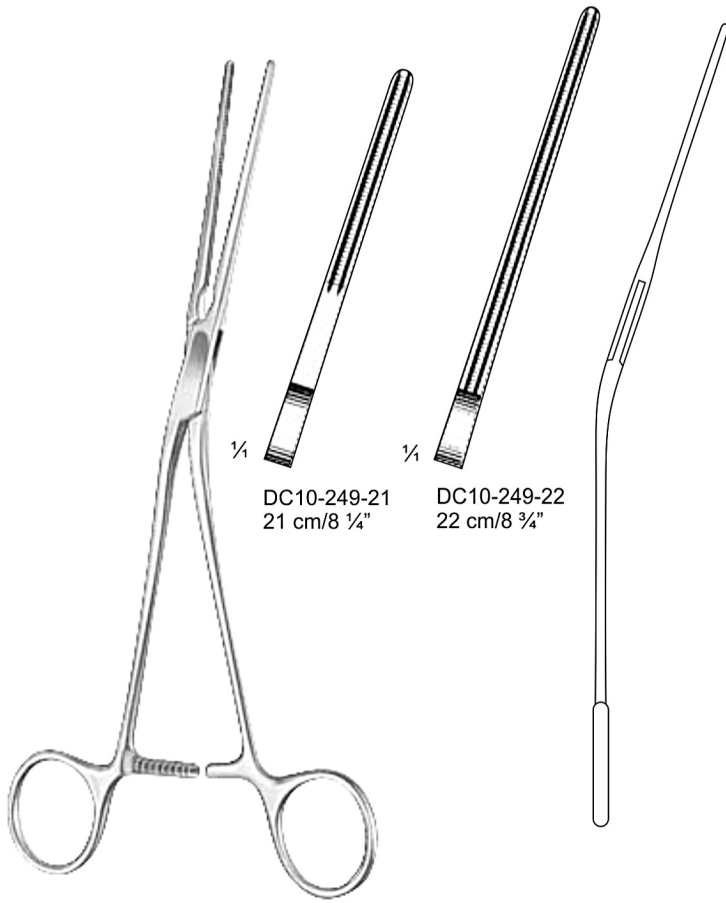

1/4

DC10-249-21
21 cm/8 1/4"

1/4

DC10-249-22
22 cm/8 3/4"

Potts
DC10-249-21 - DC10-249-22

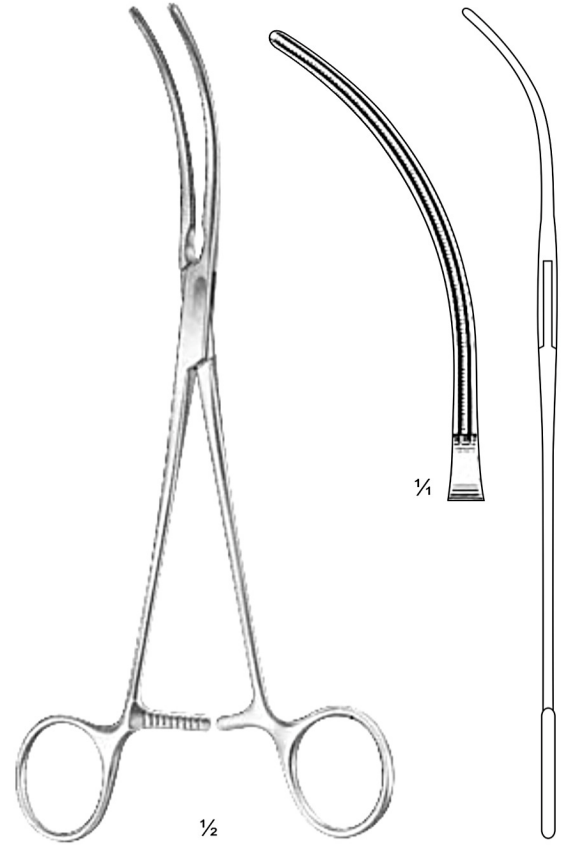

1/2

1/4

Potts
DC10-251-22
22cm /8 3/4"

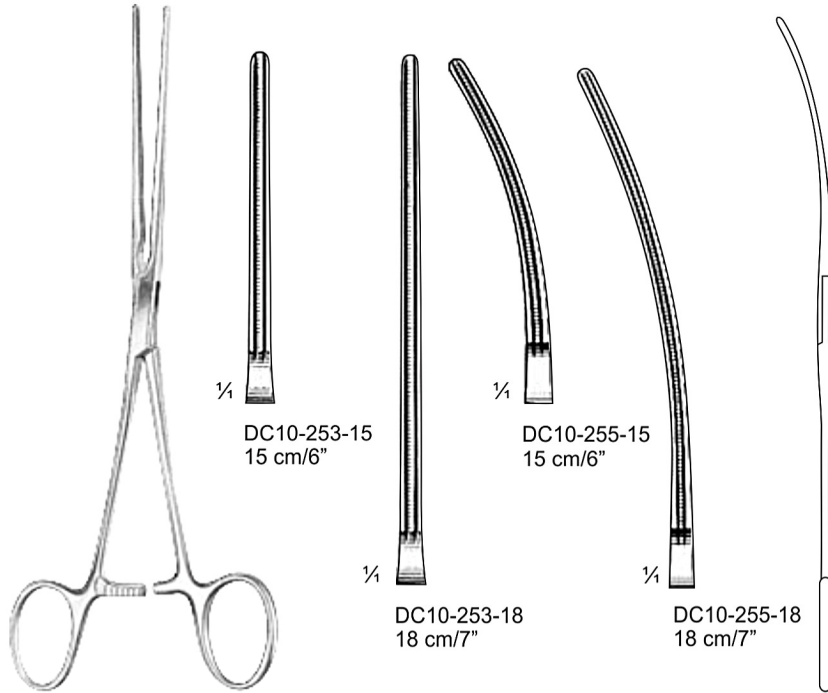

1/4

DC10-253-15
15 cm/6"

1/4

DC10-255-15
15 cm/6"

1/4

DC10-253-18
18 cm/7"

1/4

DC10-255-18
18 cm/7"

Bainbridge

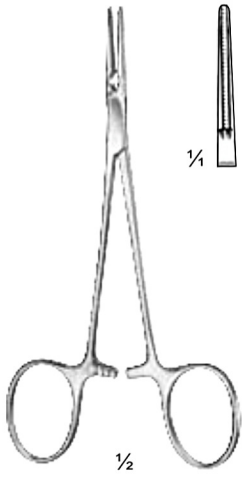

Mosquito
DC10-257-12
12 cm / 4 3/4"

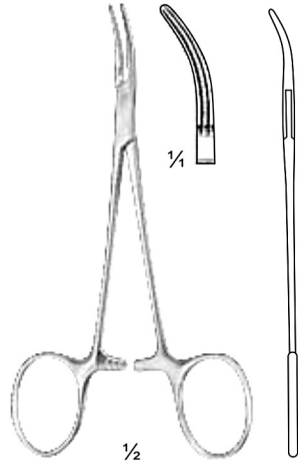

Mosquito
DC10-259-12
12 cm / 4 3/4"

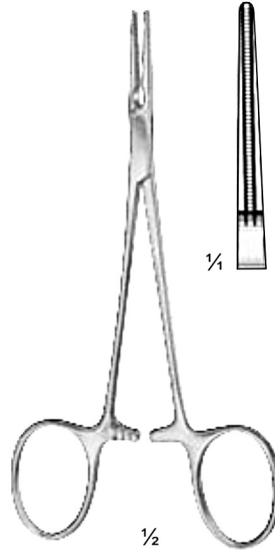

Pean
DC10-261-14
14 cm / 5 1/2"

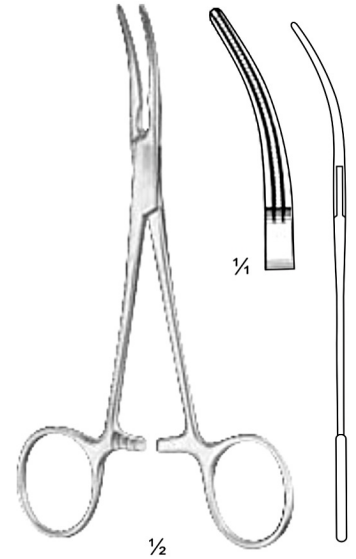

Pean
DC10-263-14
14 cm / 5 1/2"



Leland-Jones
DC10-265-18 - DC10-265-20

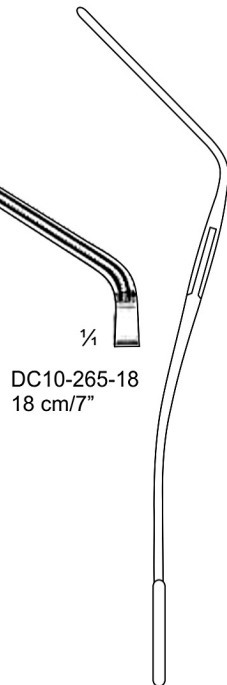

DC10-265-18
18 cm / 7"

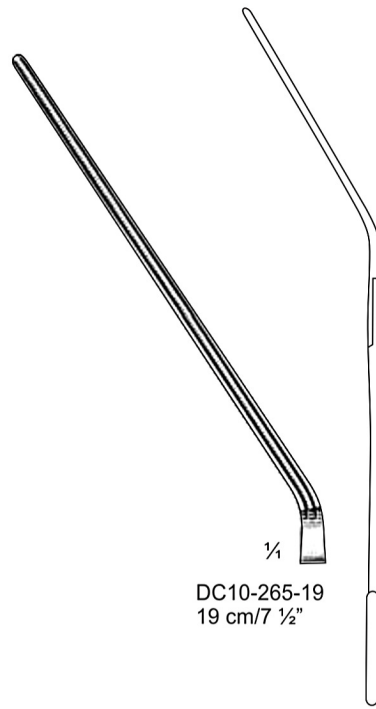

DC10-265-19
19 cm / 7 1/2"

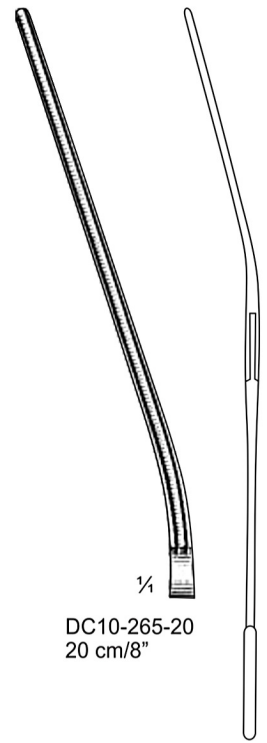

DC10-265-20
20 cm / 8"

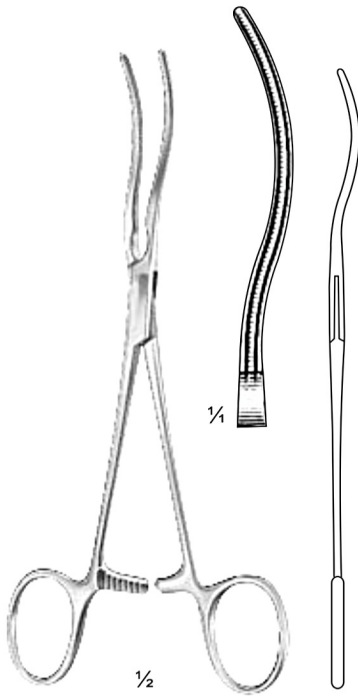

DC10-267-17
17 cm / 6 3/4"

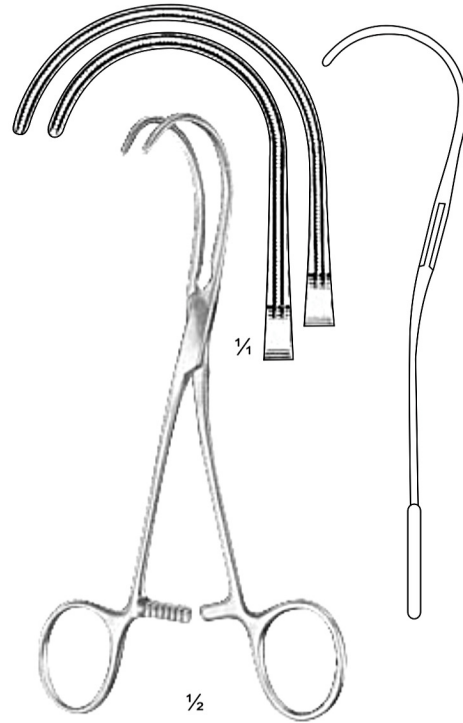

DC10-269-16 = 16 cm / 6 1/4"
DC10-271-17 = 17 cm / 6 3/4"



Glover

◀ DC10-275-20
DC10-277-20
20.5cm/8"

DC10-275-22
DC10-277-22
22cm/8 3/4"

DC10-275-26
DC10-277-26 ▶
26cm/10 1/4"

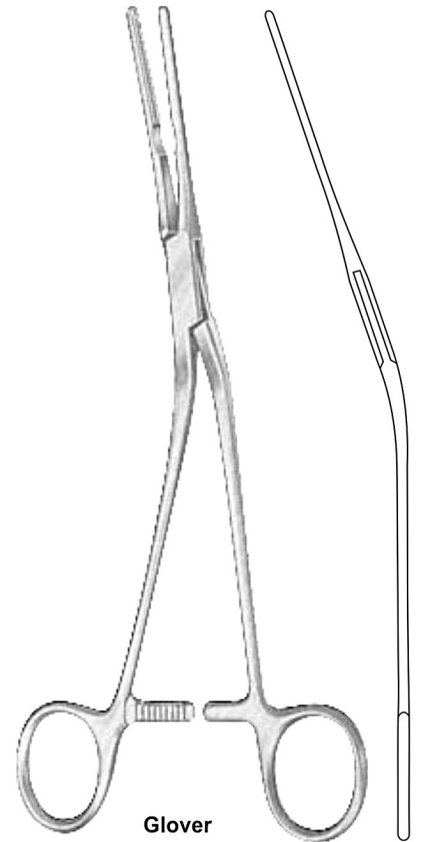

Glover

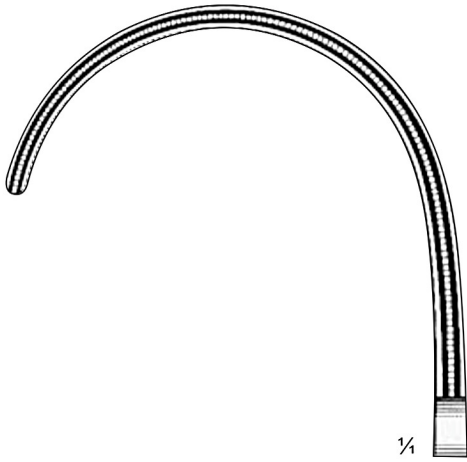

¼
DC10-279-02

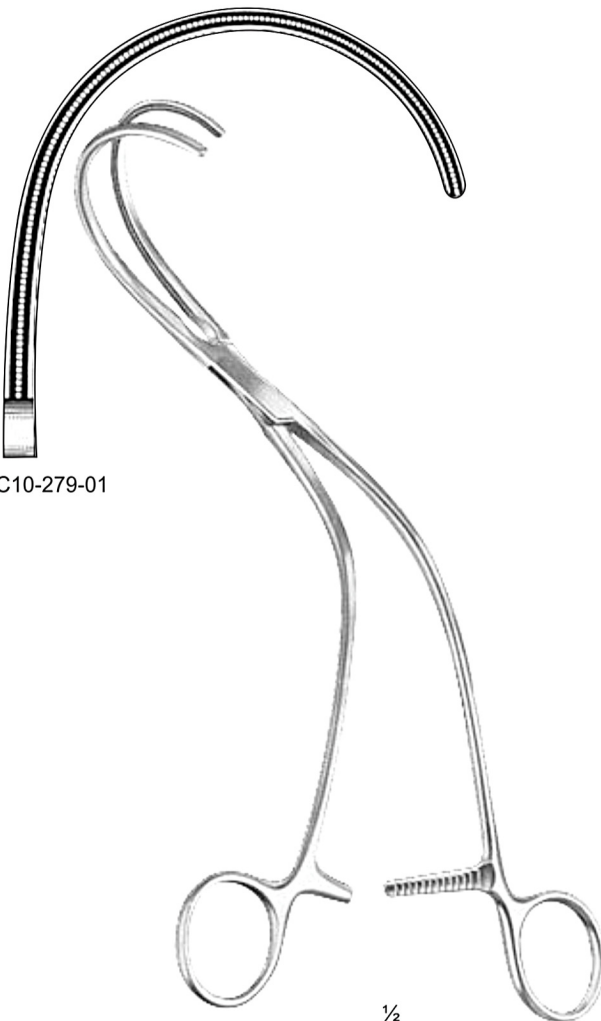

DC10-279-01

Weber
26 cm / 10 ¼"

½

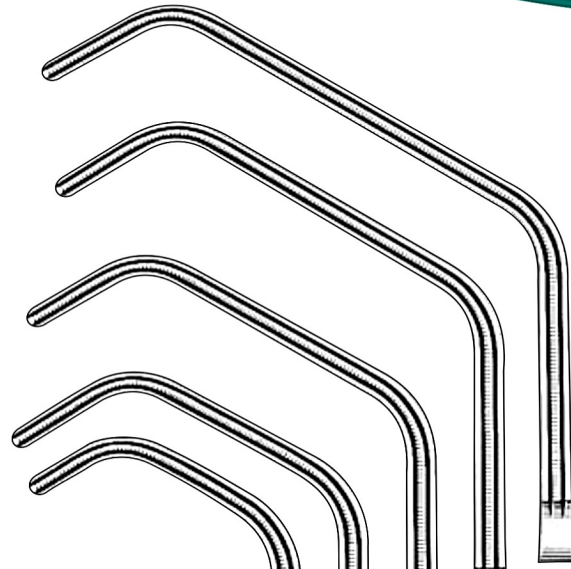

DC10-281-27
27.5 cm / 11"

DC10-281-26
26.5 cm / 10 ½"

DC10-281-25
25 cm / 10"

¼
DC10-281-24
24 cm / 9 ¾"

DC10-281-20
20.5 cm / 8"

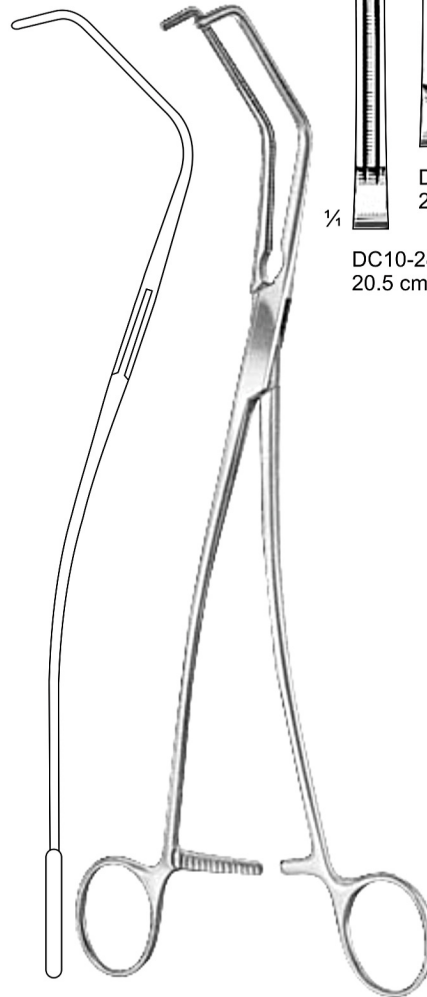

Satinsky
DC10-281-20 - DC10-281-27

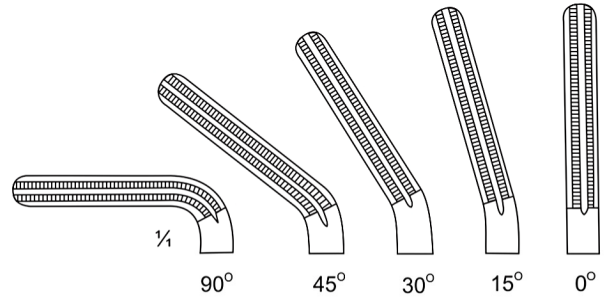

	cm	inch.	angle	weight
DC10-283-00	15	6	0°	28 g
DC10-283-15	15	6	15°	28 g
DC10-283-30	15	6	30°	28 g
DC10-283-45	15	6	45°	28 g
DC10-283-90	14	5 ½	90°	28 g

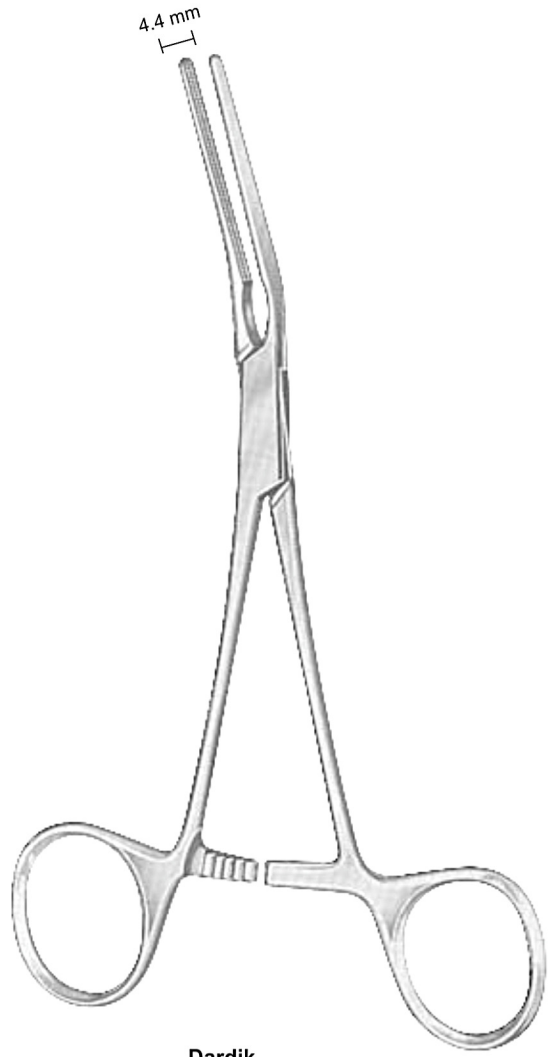

Dardik

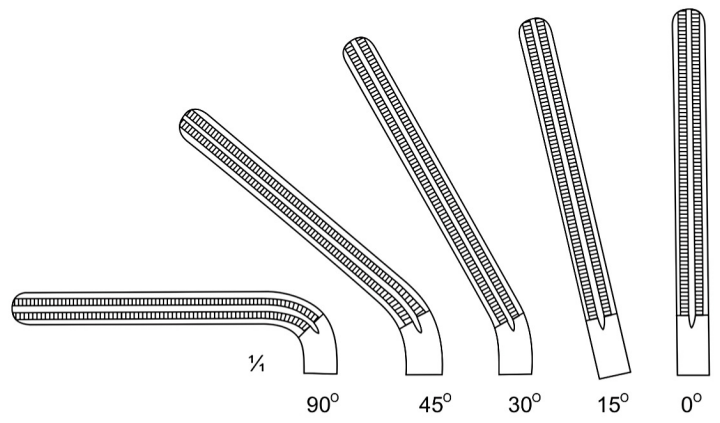

	cm	inch.	angle	weight
DC10-285-00	17	6 ¾	0°	28 g
DC10-285-15	17	6 ¾	15°	28 g
DC10-285-30	17	6 ¾	30°	28 g
DC10-285-45	17	6 ¾	45°	28 g
DC10-285-90	16	6 ¼	90°	28 g

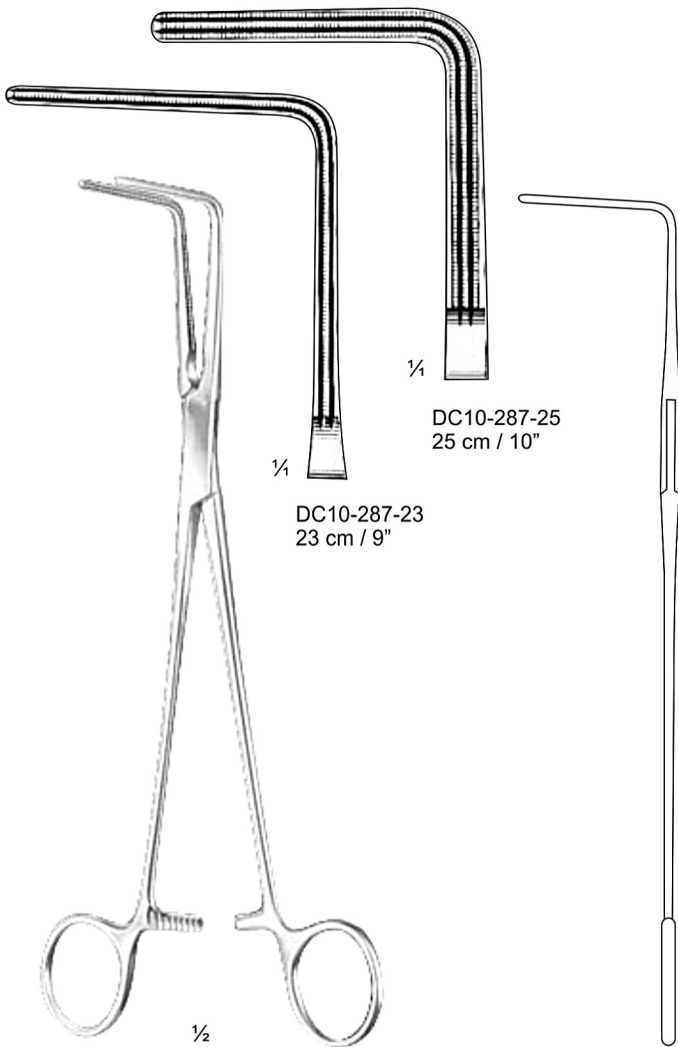

Lees
DC10-287-23 - DC10-287-25

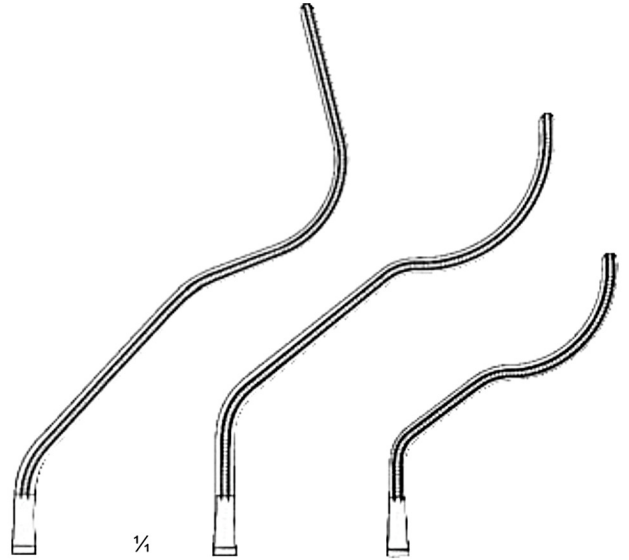

DC10-289-18
18cm/7"

DC10-289-16
16cm/6 1/4"

DC10-289-14
14cm/5 1/2"

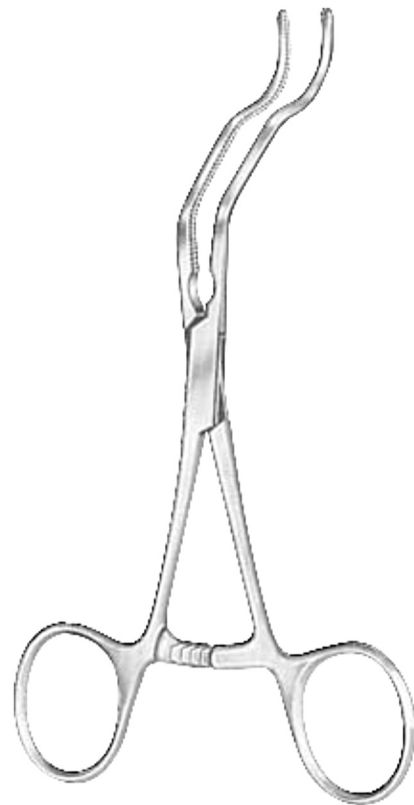

Gregory

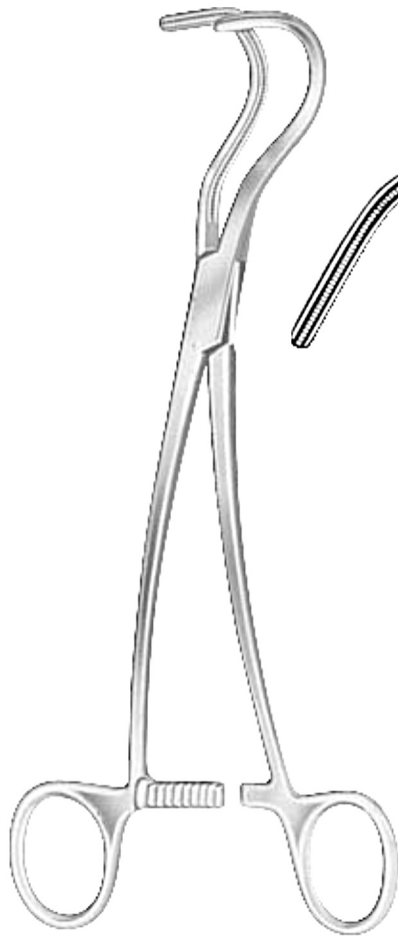

Wylie "J"

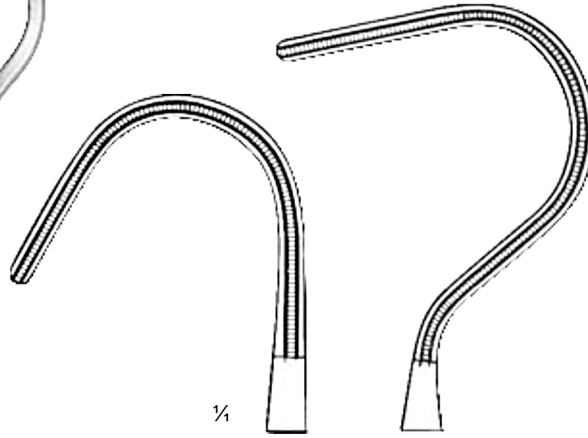

¼
DC10-291-21
21cm/8¼"

¼
DC10-291-22
22cm/8¾"

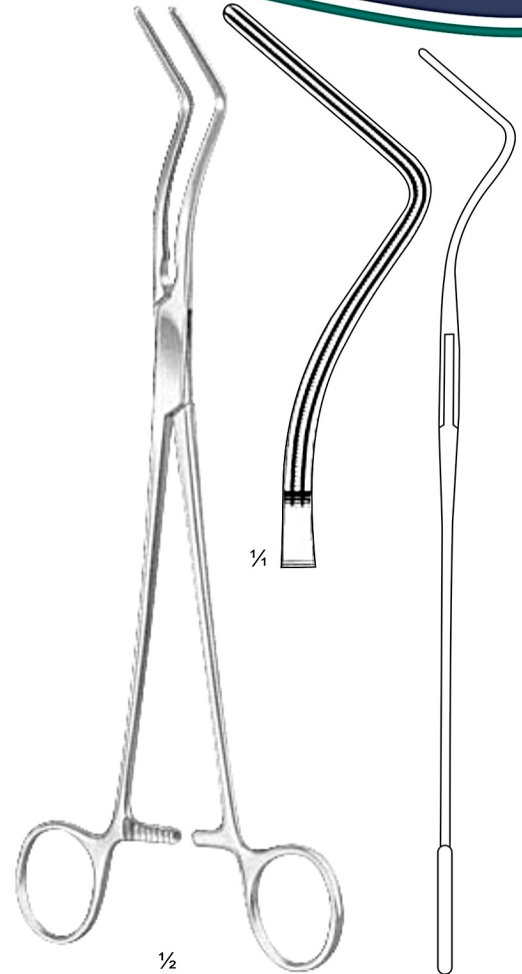

½
Lees
DC10-293-25
25 cm /10"

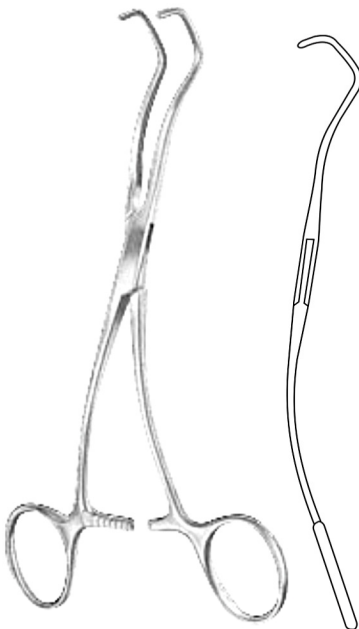

Derra
DC10-295-16 - DC10-295-18

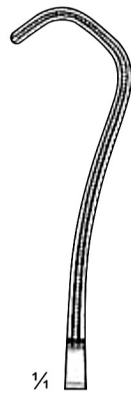

¼
DC10-295-16
16 cm /6 ¼"



¼
DC10-295-17
17 cm /6 ¾"



¼
DC10-295-18
18 cm /7"

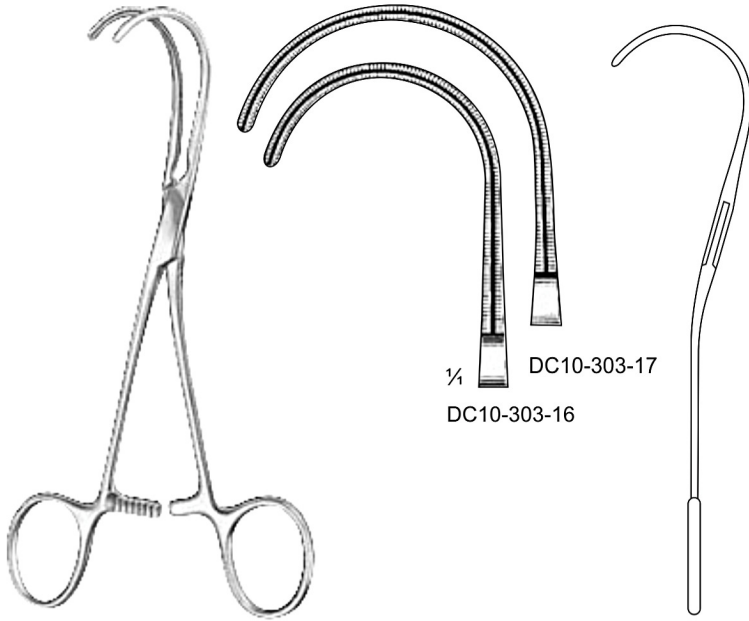

Cooley
DC10-303-16 = 16 cm / 6 1/4"
DC10-303-17 = 17 cm / 6 3/4"

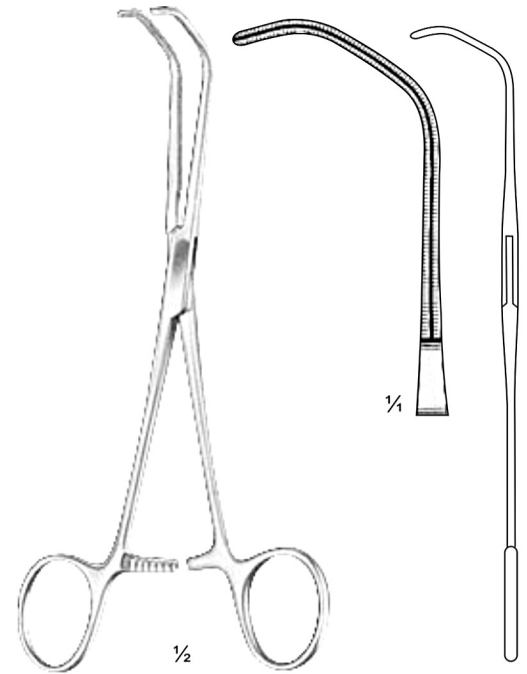

Beck
DC10-305-17
17 cm / 6 3/4"

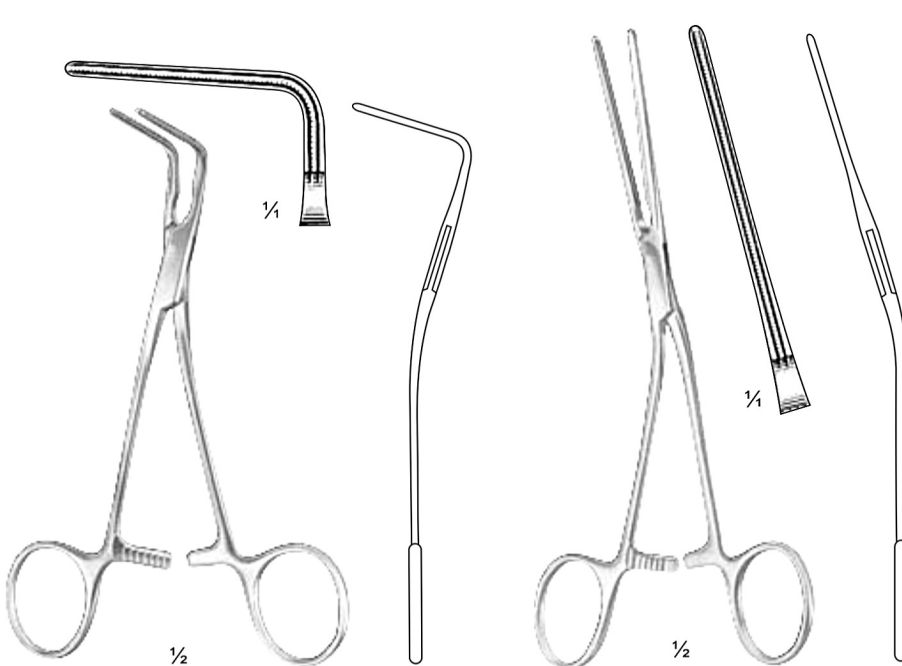

DeBailey
DC10-307-15
15 cm / 6"

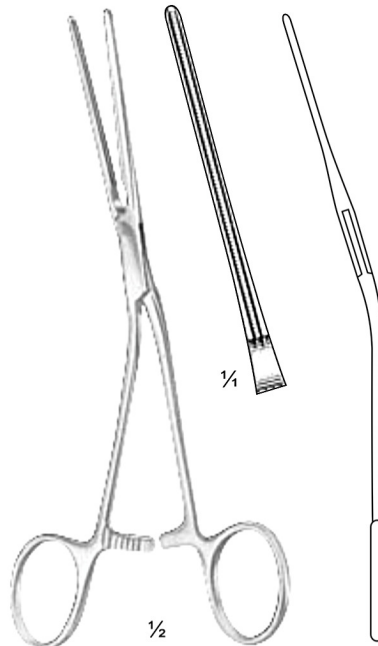

DeBailey
DC10-309-17
17 cm / 6 1/4"

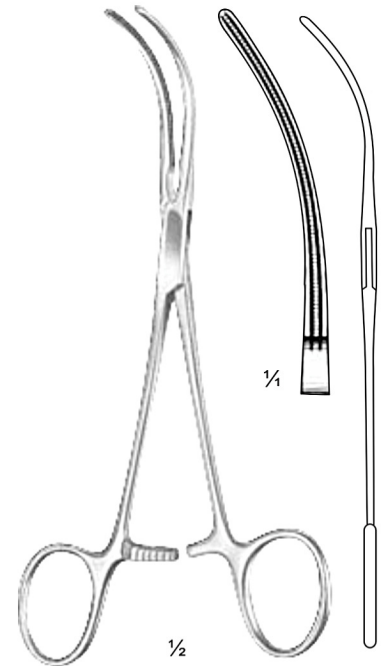

Glover
DC10-311-17
17 cm / 6 3/4"

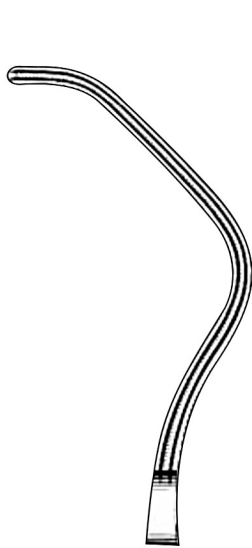

DC10-313-03
24 cm/9 1/2"

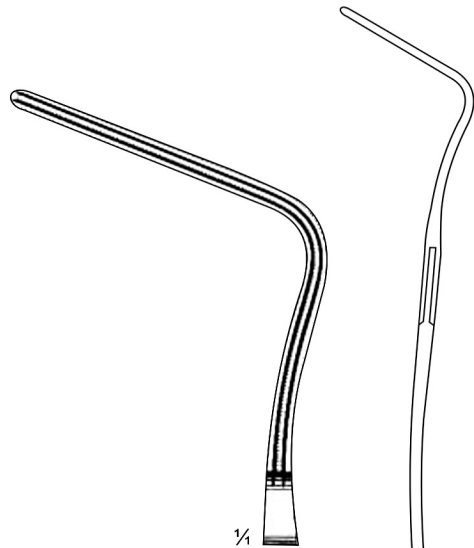

1/4
DC10-313-04
24 cm/9 1/2"

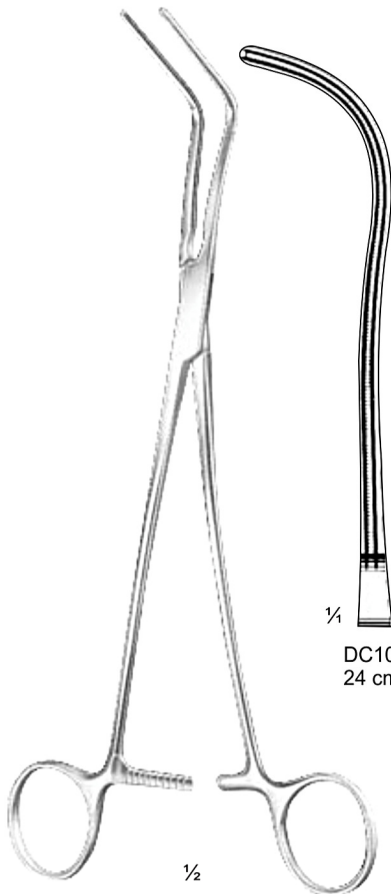

1/4
DC10-313-01
24 cm/9 1/2"

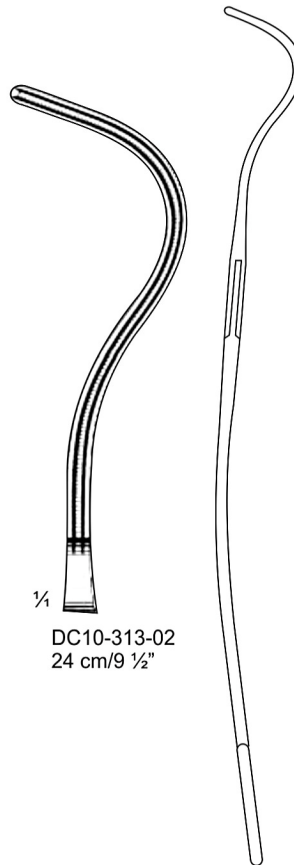

1/4
DC10-313-02
24 cm/9 1/2"

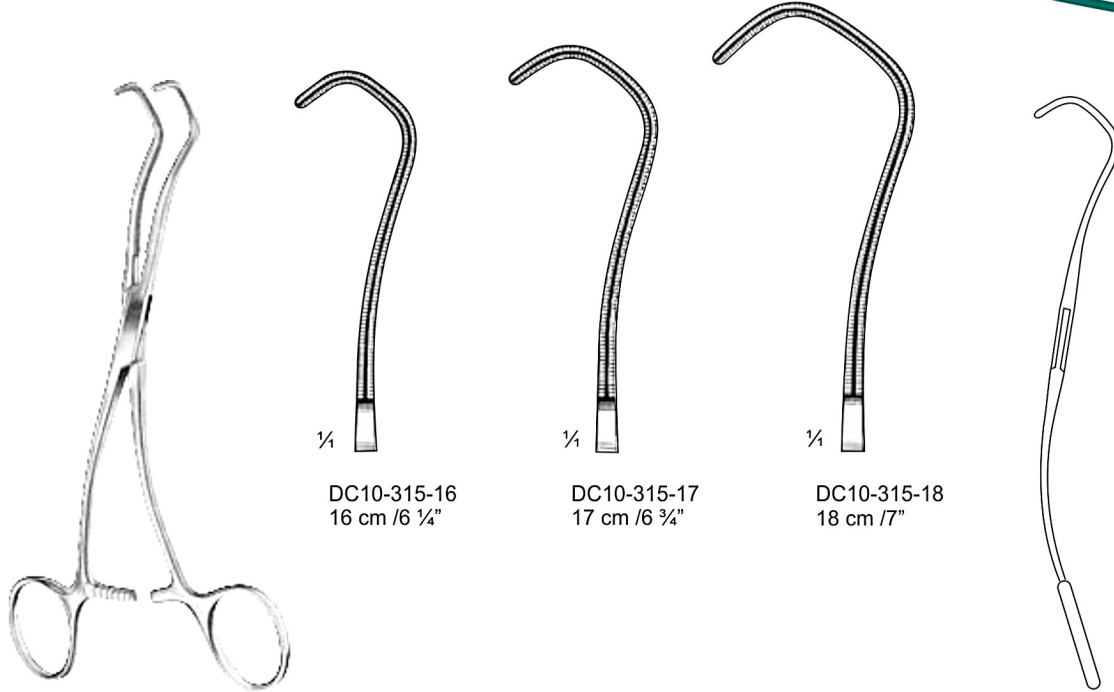

1/4

DC10-315-16
16 cm / 6 1/4"

1/4

DC10-315-17
17 cm / 6 3/4"

1/4

DC10-315-18
18 cm / 7"

Cooley-Derra
DC10-315-16 - DC10-315-18

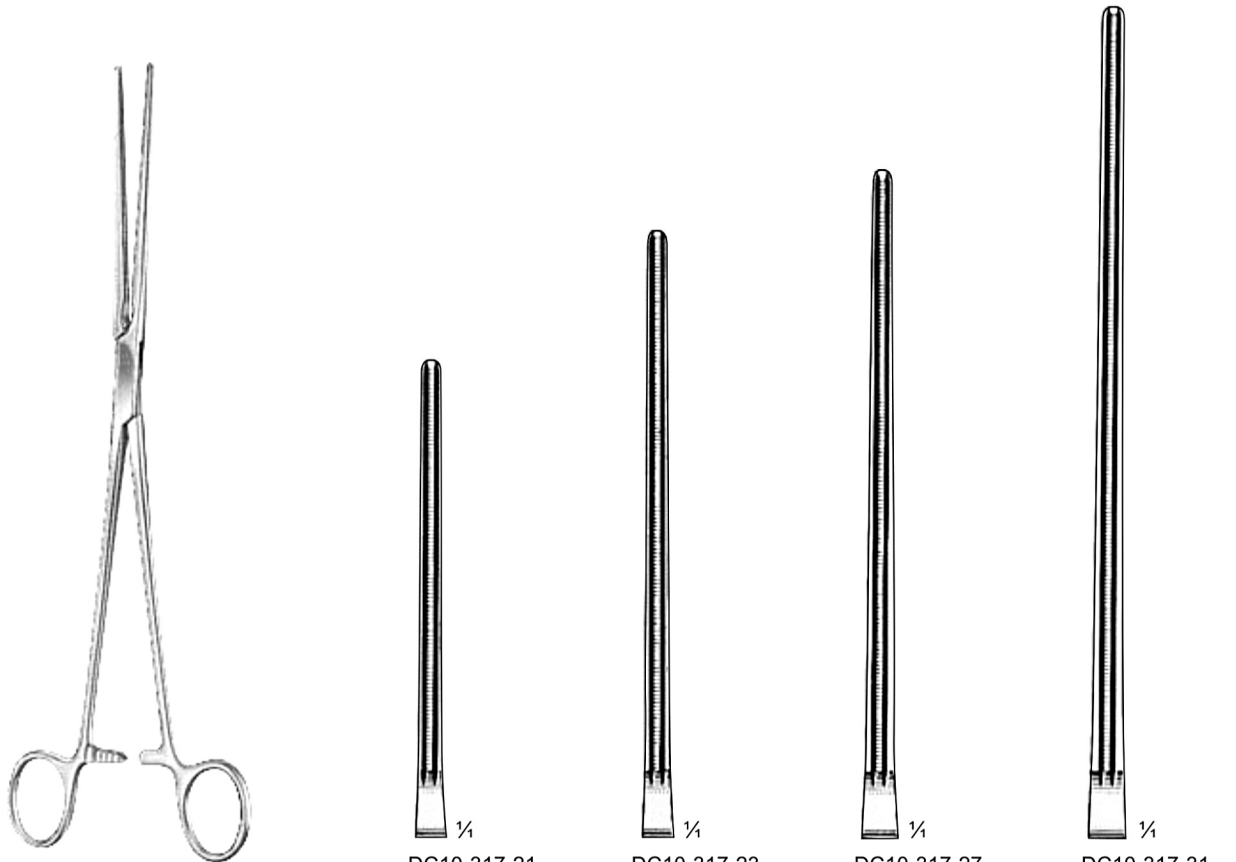

1/4

DC10-317-21
21.5 cm / 8 1/2"

1/4

DC10-317-23
23 cm / 9"

1/4

DC10-317-27
27 cm / 10 1/2"

1/4

DC10-317-31
31.5 cm / 12 1/2"

DC10-317-21 - DC10-317-31

INTERNATIONAL CRIMSON



DC10-331-21 - DC10-331-31



DC10-331-21
21.5 cm / 8 1/2"



DC10-331-23
23 cm / 9"

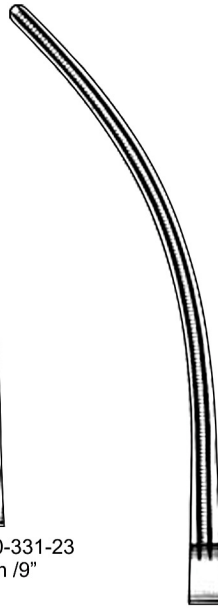

DC10-331-27
27 cm / 10 1/2"



DC10-331-31
31 cm / 12 1/2"

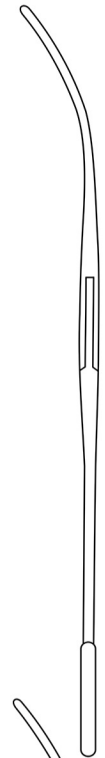

DC10-333-26 - DC10-333-33

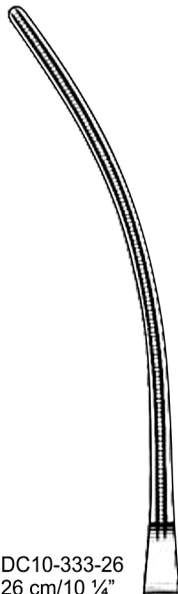

DC10-333-26
26 cm / 10 1/4"

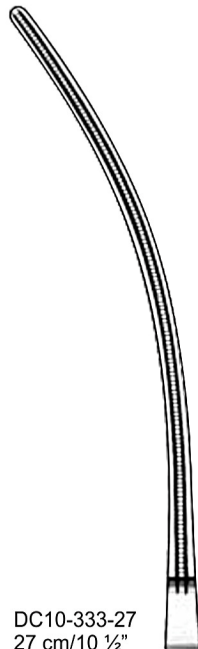

DC10-333-27
27 cm / 10 1/2"

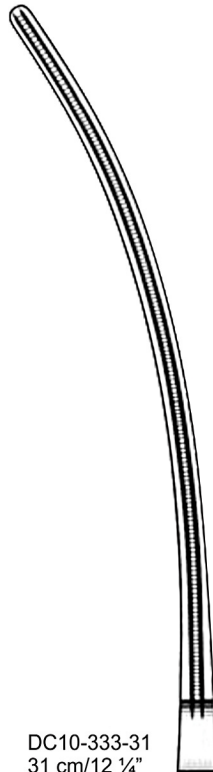

DC10-333-31
31 cm / 12 1/4"

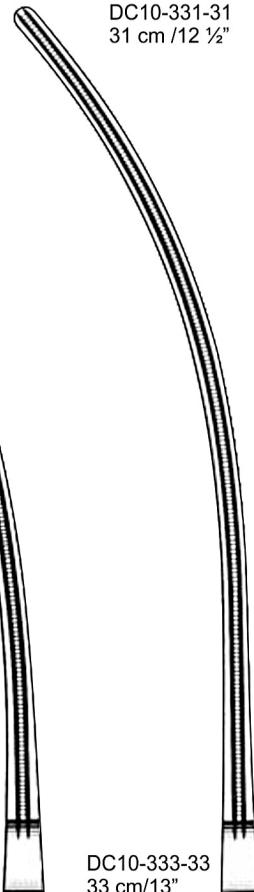

DC10-333-33
33 cm / 13"

