

Surgical Instruments

Crimson International is proudly the most sought after name in the field of Medical Surgical Instruments. Since its birth, the chief aim of our company has been to utilize all its energies, manpower and technology towards developing superior quality instruments, with special emphasis on them being technically precise as well as user friendly. In order to serve the interest and meet the requirement of our customers, we endeavor to best of our abilities to improve our existing line and also introduce new products.

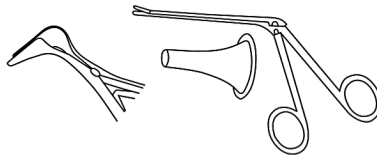

18

Rehnology, Otology, Mouth

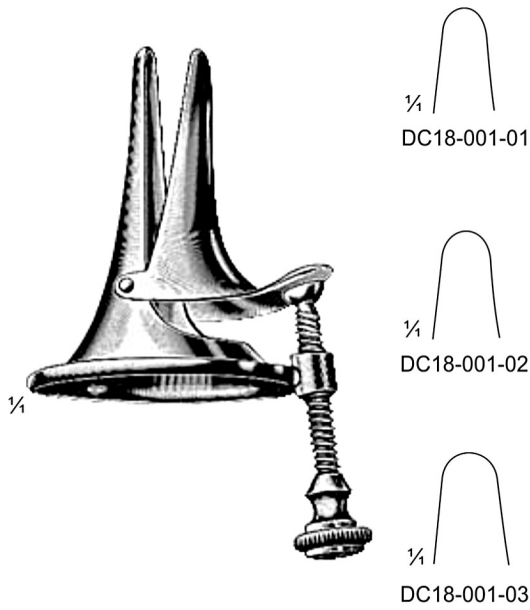

Voltolini
DC18-001-01 - DC18-001-03

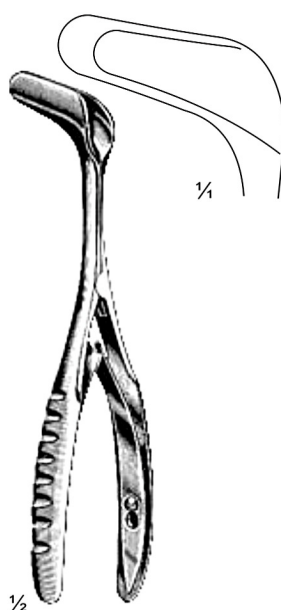

Schwarz
DC18-003-14
14 cm/5 1/2"

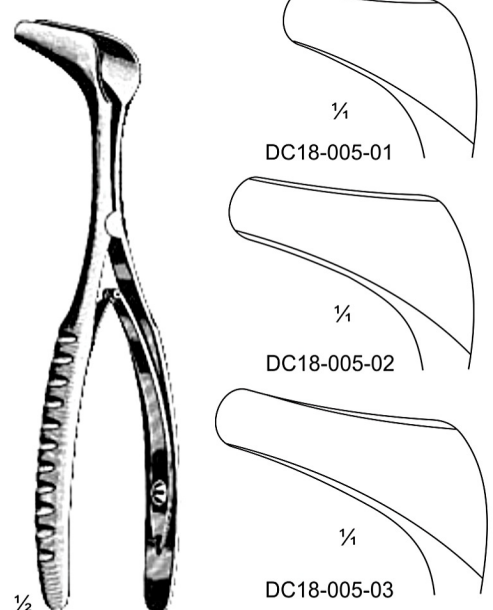

Hartmann-Halle
15 cm/6"

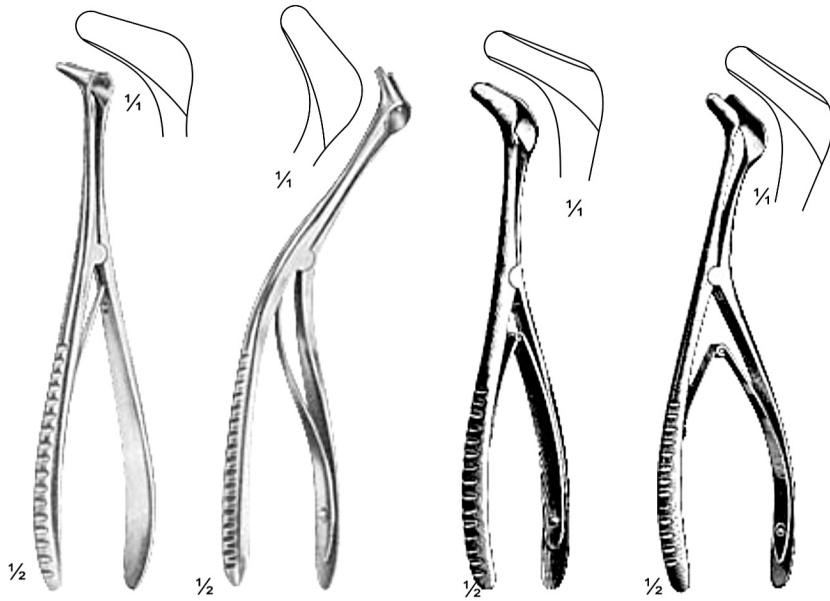

Mod. Martin
DC18-007-13
13 cm/5"
straight
for infants

Mod. Martin
DC18-009-13
13 cm/5"
curved
for infants

Tieck-Halle
DC18-011-13
13.5 cm/5 1/4"
for children

Tieck-Halle
DC18-013-13
13.5 cm/5 1/4"
for children

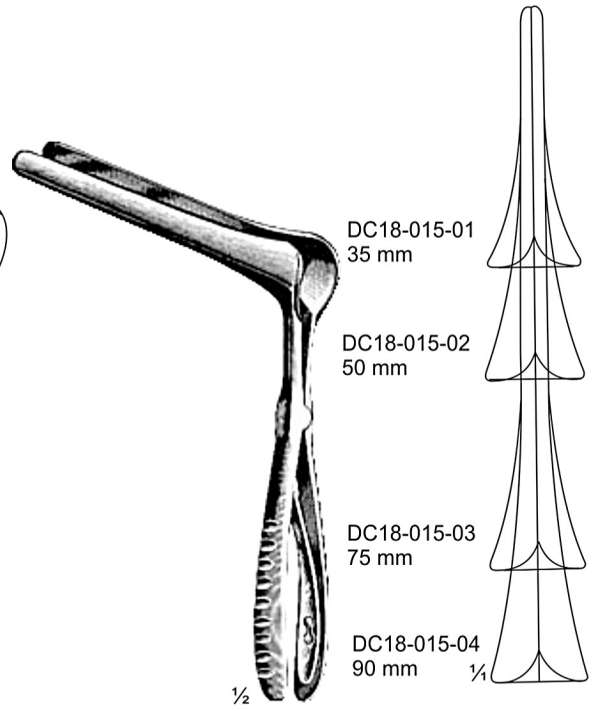

Killian
13 cm/5"
nasal and nasopharyngeal

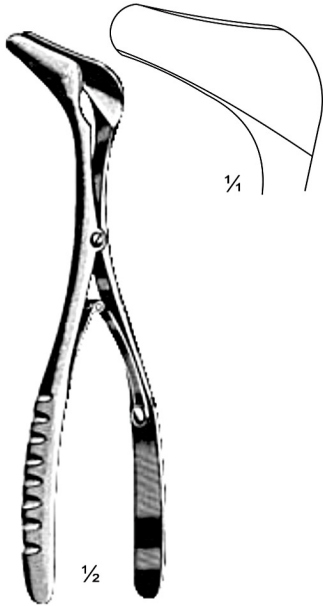

Mod. Wein
DC18-017-14
14.5 cm/5 3/4"



Cottle
14 cm/5 1/2"

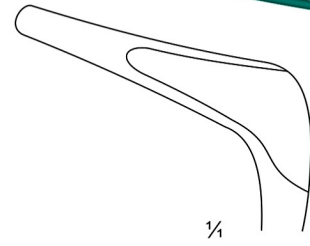

DC18-019-45

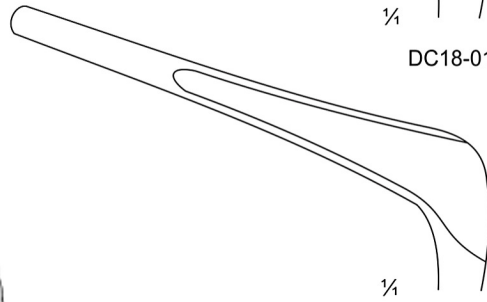

DC18-019-75

Dull black chromium plated



Cottle
DC18-021-35-90
15 cm/6"

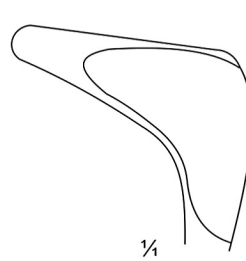
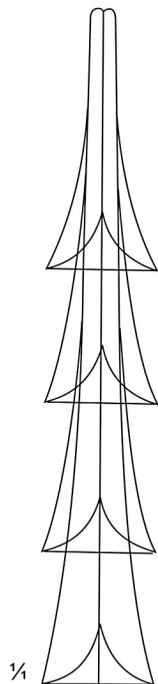

DC18-021-35

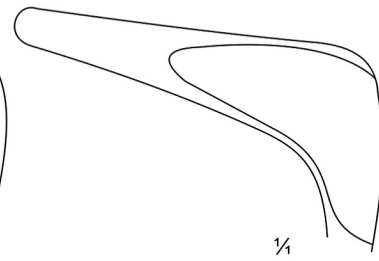

DC18-021-50

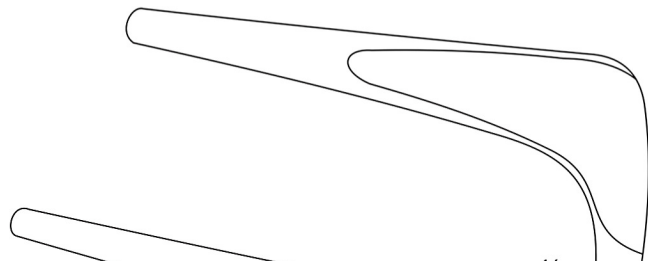

DC18-021-75

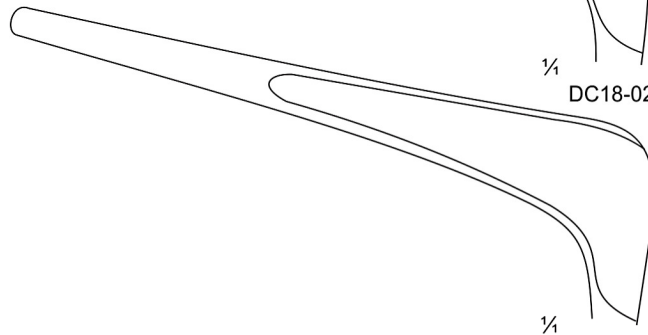

DC18-021-90



Westmacott
DC18-023-20
Nasal Polypus Forceps



Lubet-Barbon
DC18-025-20
Nasal Polypus Forceps

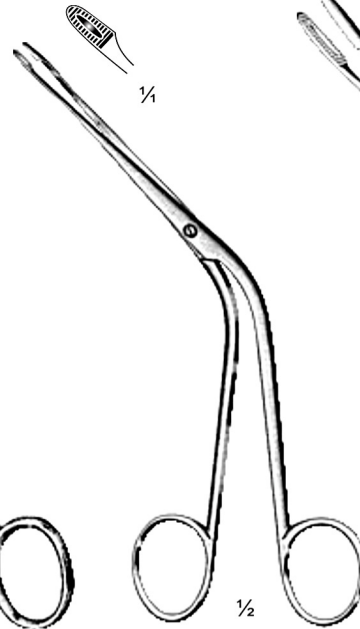

Hartmann
DC18-027-16
16 cm/6 1/4"
Nasal Polypus Forceps

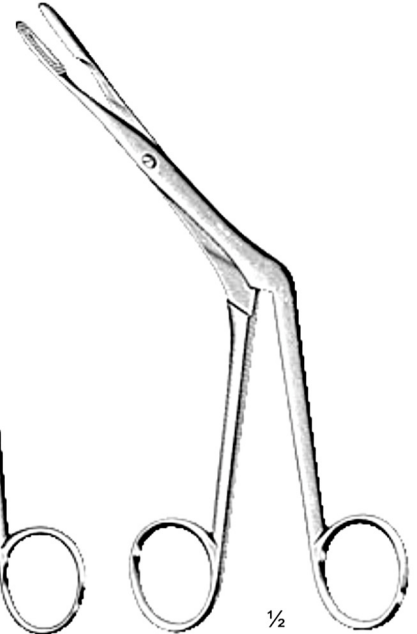

Hartmann-Knight
DC18-029-18
18 cm/7"
Nasal Polypus Forceps

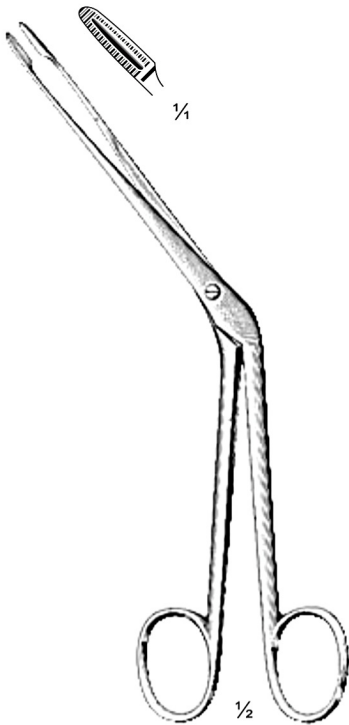

Hartmann
DC18-031-20
20 cm/8"
Nasal Polypus Forceps

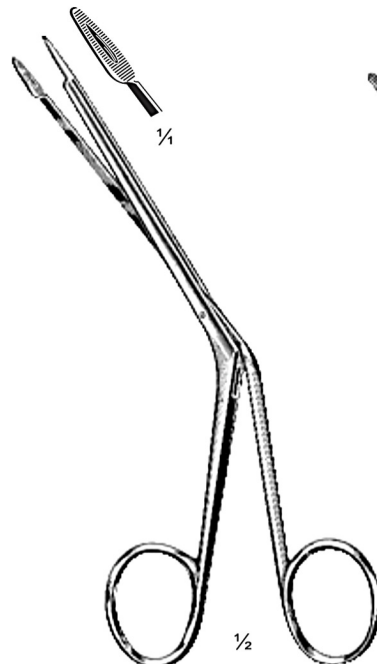

Littauer
DC18-033-18
18 cm/7"
Nasal Polypus Forceps

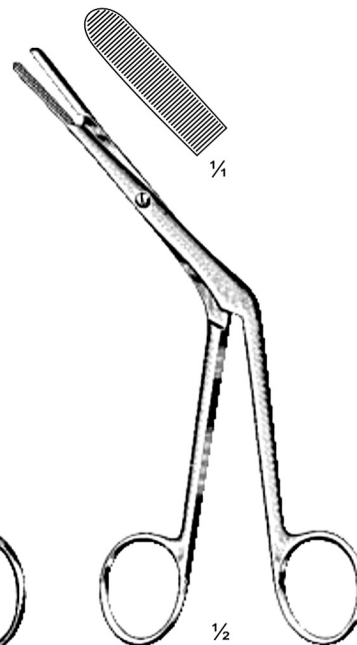

Killian
DC18-035-17
17 cm/6 3/4"
Septum Compression Forceps

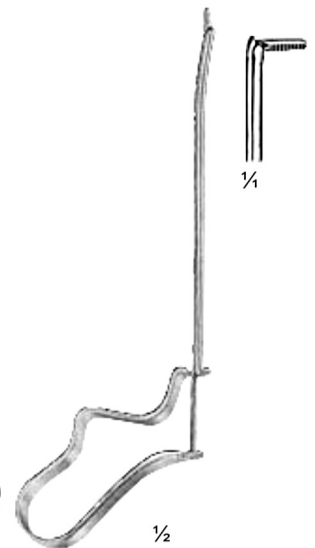

Quire
DC18-037-12
12 cm/4 3/4"
Foreign Body Forceps

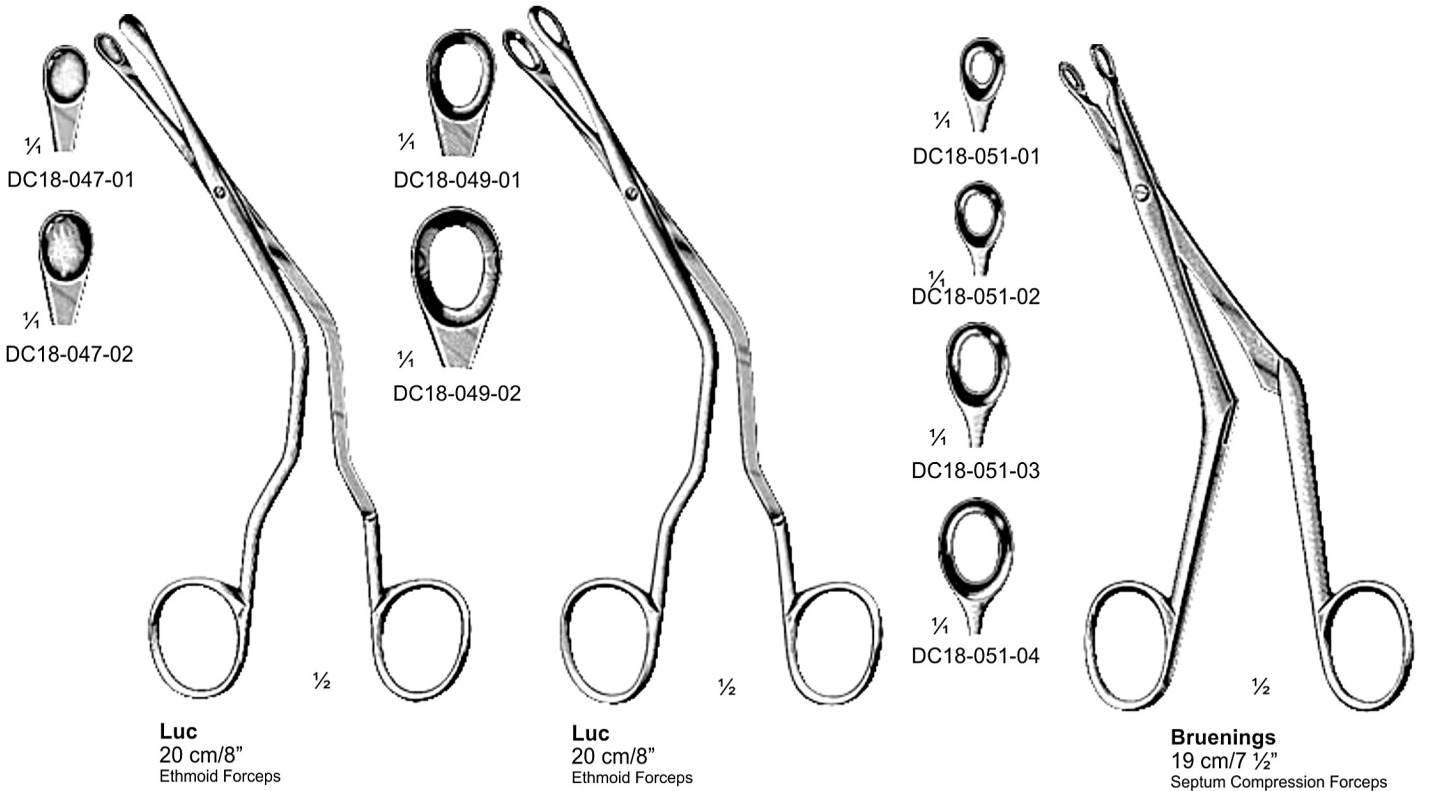
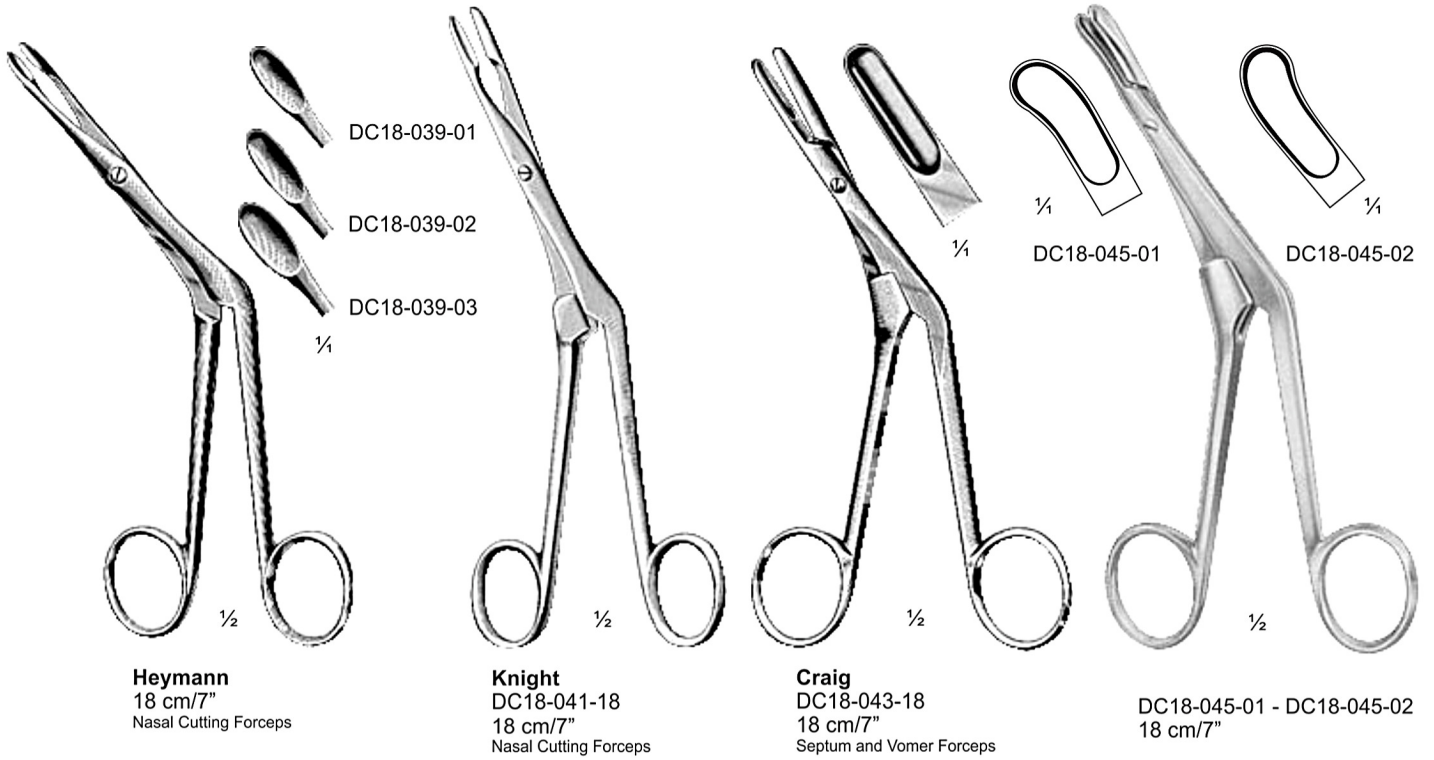

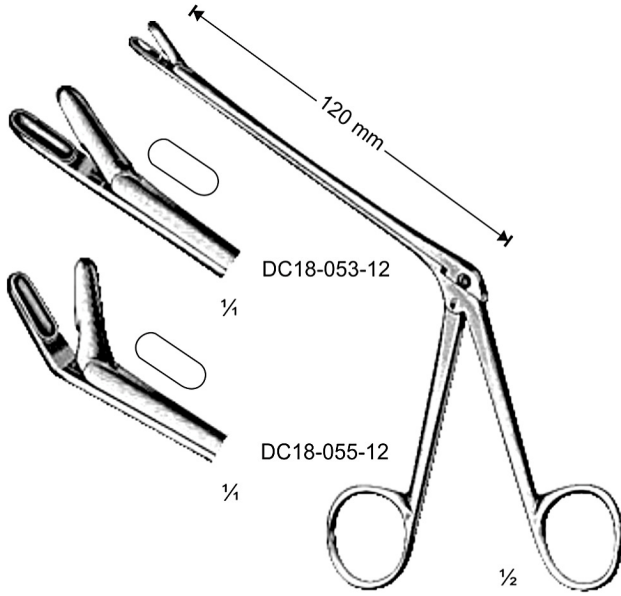

Takahashi
19 cm/7 1/2"
Ethmoid Forceps

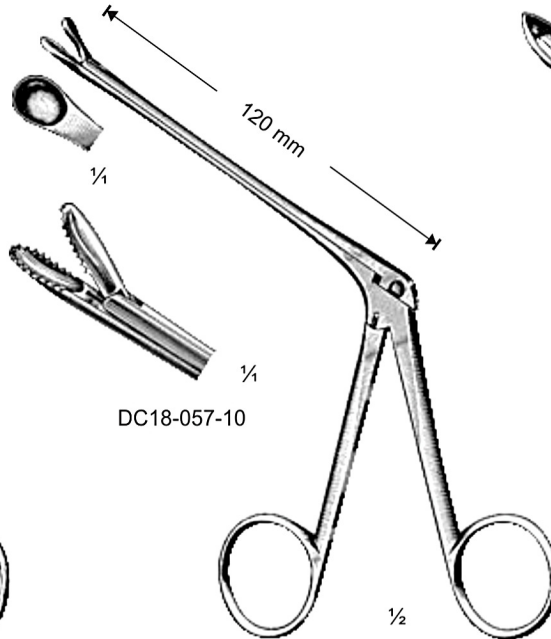

Watson-Williams
DC18-057-12
19 cm/7 1/2"
Ethmoid Forceps



Weil
DC18-059-12
19 cm/7 1/2"
Nasal Cutting Forceps

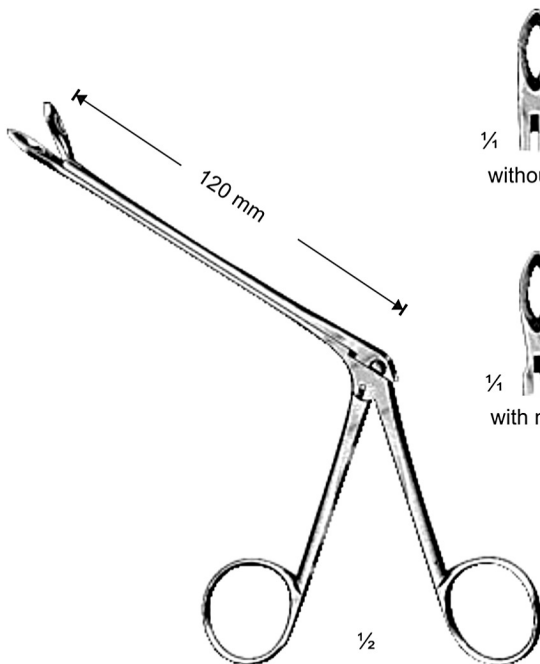

Weil-Blakesley
19 cm/7 1/2"
Nasal Cutting Forceps

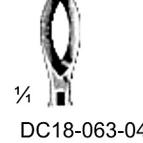
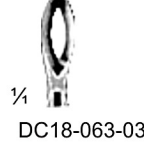
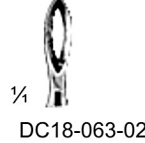
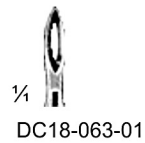

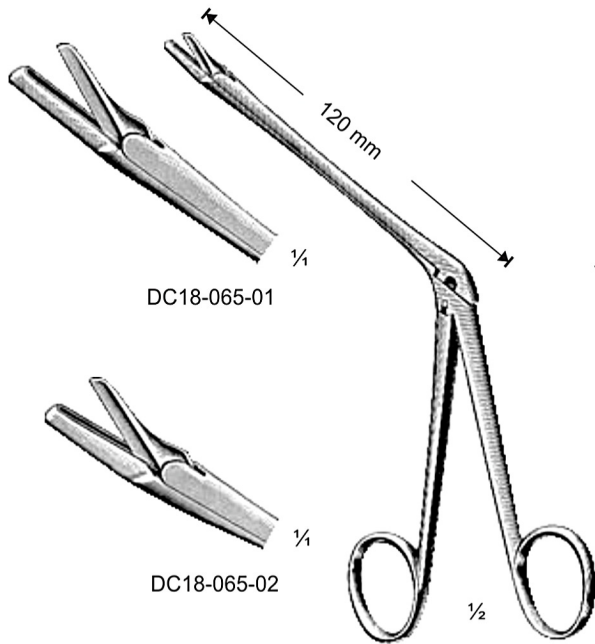





DC18-065-01

DC18-065-02

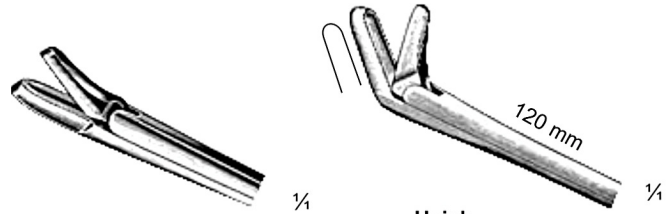

Struycken
19 cm/7 1/2"

-  DC18-067-01
2.2 mm
-  DC18-067-02
2.6 mm
-  DC18-067-03
3.0 mm
-  DC18-067-04
3.4 mm



Hajek
DC18-071-12
19 cm/7 1/2"



-  DC18-069-01
-  DC18-069-02
-  DC18-069-03

Myles
19 cm/7 1/2"

Hajek
19 cm/7 1/2"

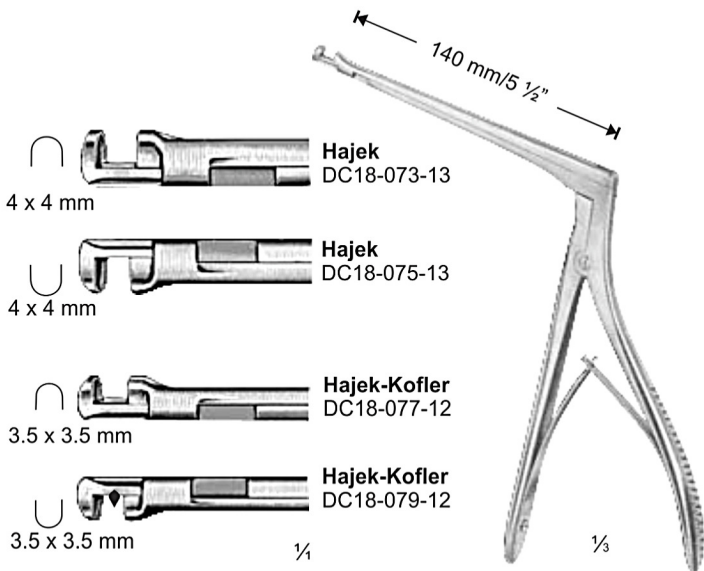



 **Hajek**
DC18-073-13
4 x 4 mm

 **Hajek**
DC18-075-13
4 x 4 mm

 **Hajek-Kofler**
DC18-077-12
3.5 x 3.5 mm

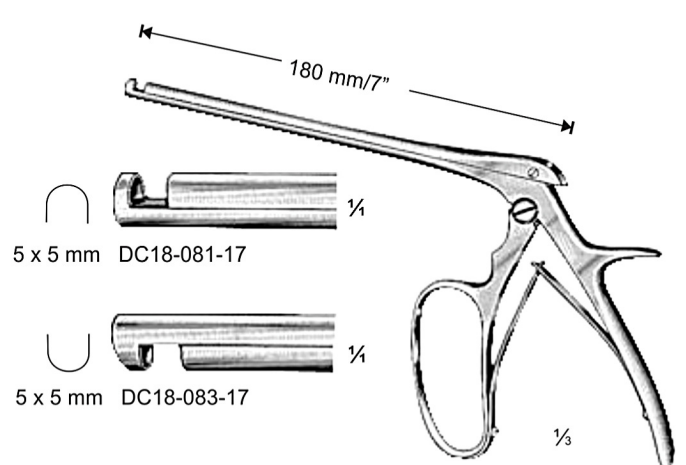

 **Hajek-Kofler**
DC18-079-12
3.5 x 3.5 mm



 5 x 5 mm DC18-081-17

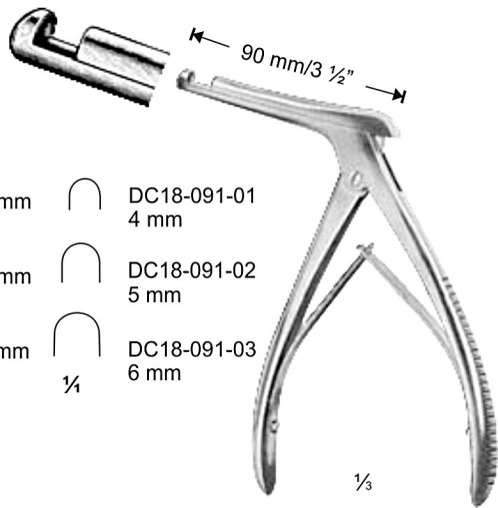



 5 x 5 mm DC18-083-17

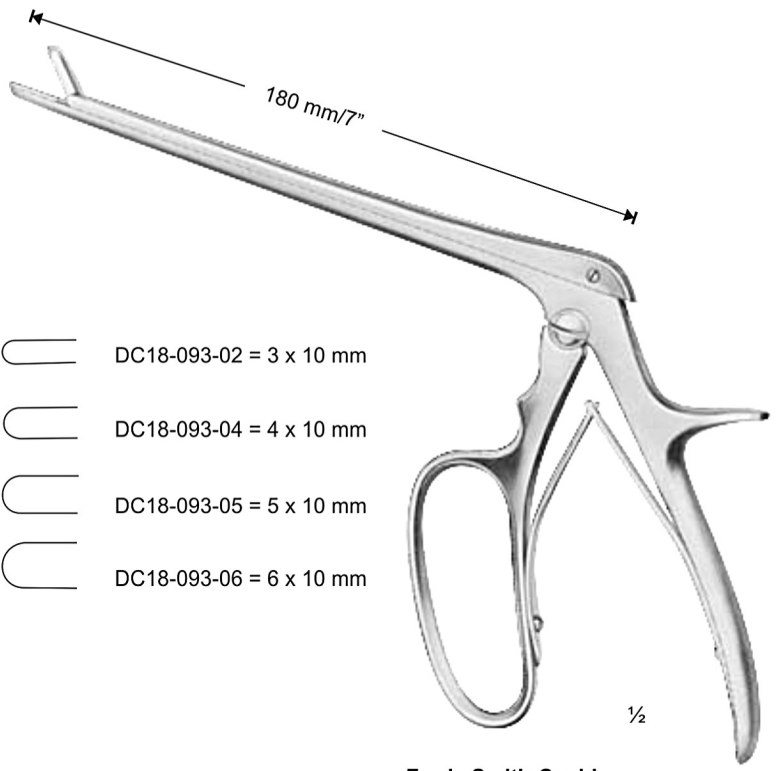

- 4 x 4 mm  DC18-091-01
4 mm
- 5 x 5 mm  DC18-091-02
5 mm
- 6 x 6 mm  DC18-091-03
6 mm

Kerrison
20 cm/8"
Antrum Rongeur Forceps,
not-through cutting



-  DC18-093-02 = 3 x 10 mm
-  DC18-093-04 = 4 x 10 mm
-  DC18-093-05 = 5 x 10 mm
-  DC18-093-06 = 6 x 10 mm

Ferris Smith-Cushing
Sphenoid Nibble Forceps

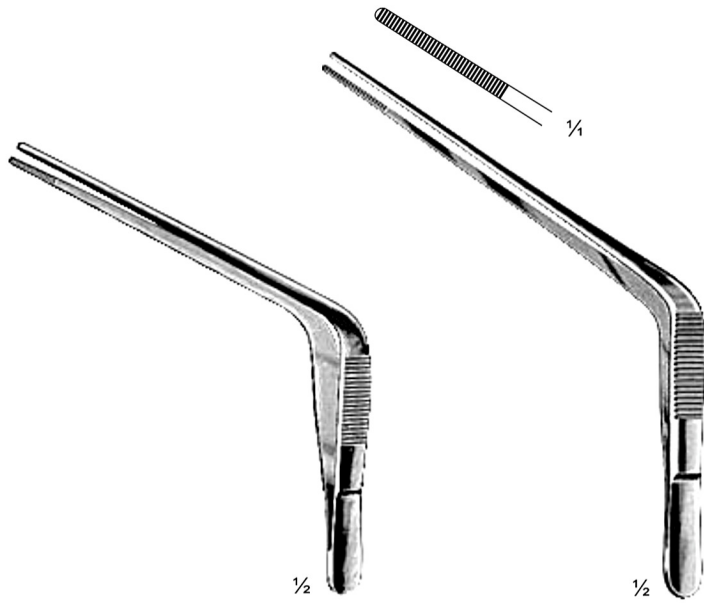

Troeltsch
DC18-095-15
15 cm/6"

Troeltsch
DC18-097-18
18 cm/7"



Gruenwald (Jansen)
DC18-099-20
20 cm/8"

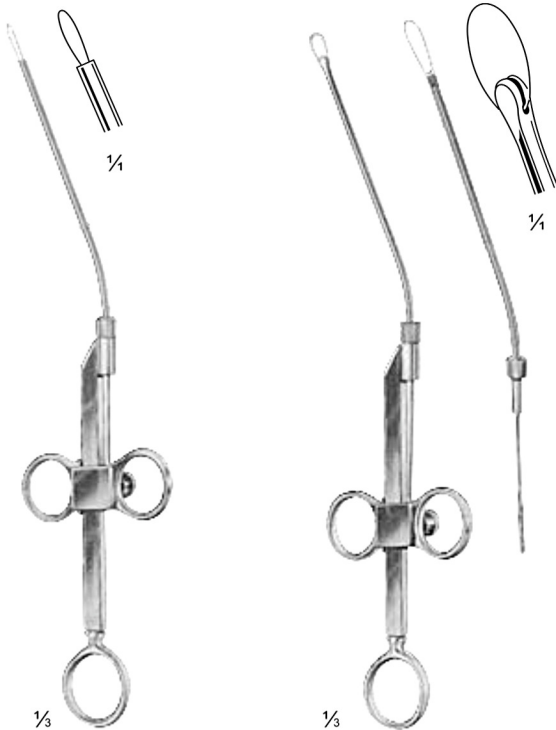

Krause
DC18-101-26
with 1 cannula

Krause-Voss
DC18-103-26
with 2 cannula

Lange-Wilde
DC18-105-24
with 1 cannula

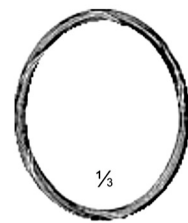

DC18-107-30 = 0.3 mm ø
DC18-107-40 = 0.4 mm ø
10 m/33 ft.
Steel Wire for nasal snares, in coils



DC18-109-12
0.3 mm ø
Steel Wire Loops, shaped,
in bundles of 1 dozen each

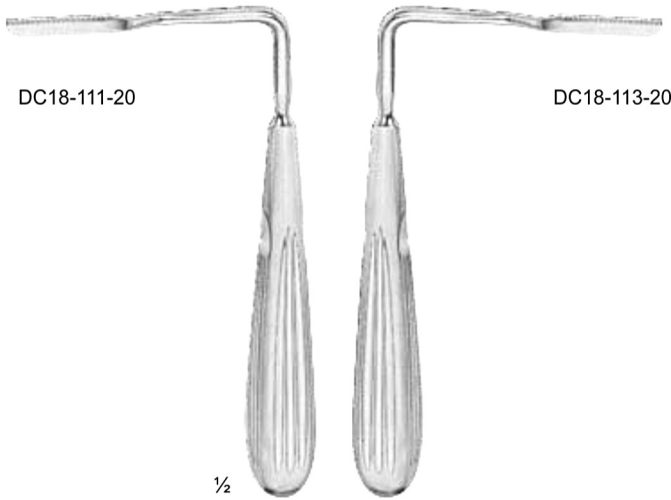

Joseph
Nasal Saws, right-angled



Joseph
DC18-115-15
Nasal Saw Protector and Guide

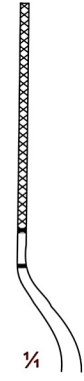

DC18-117-01



DC18-117-02

Joseph
DC18-117-01 - DC18-117-02
19 cm/7 1/2"
Nasal Saw, bayonet shaped

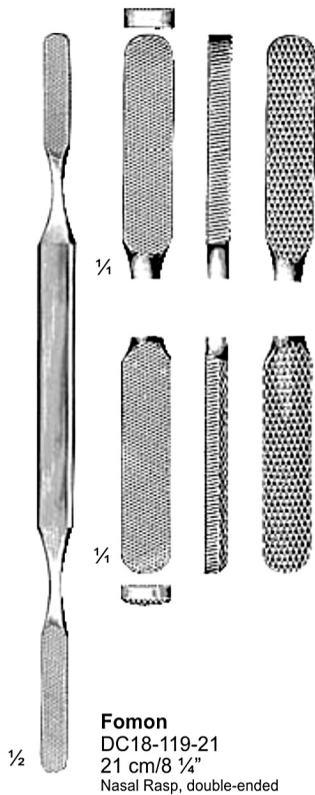

Fomon
DC18-119-21
21 cm/8 1/4"
Nasal Rasp, double-ended

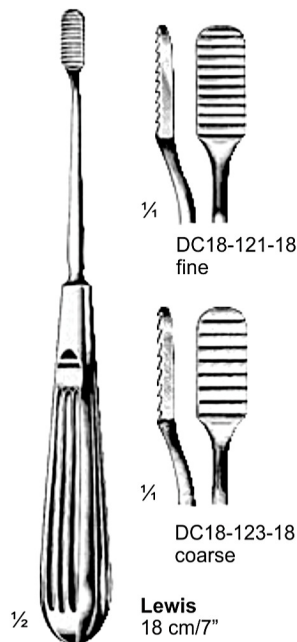

DC18-121-18
fine

DC18-123-18
coarse

Lewis
18 cm/7"



Joseph
DC18-125-15
15 cm/6"
Muscous Hook



Cottle
DC18-127-16
16 cm/6 1/4"



Beckmann
22 cm/8 3/4"



DC18-145-01



DC18-145-04



DC18-145-02



DC18-145-05



1/4
DC18-145-03



St. Clair-Thomson
21 cm/8 1/4"



DC18-147-01



DC18-147-04



DC18-147-02

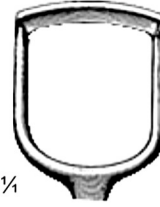

1/4
DC18-147-03



Vogel
DC18-149-21
21 cm/8 1/4"



Beckmann
DC18-151-01
DC18-151-06
22 cm/8 3/4"



1/4
DC18-151-01
DC18-153-01



DC18-151-02
DC18-153-02



DC18-151-03
DC18-153-03



1/4
DC18-151-04
DC18-153-04



DC18-151-05
DC18-153-05



DC18-151-06
DC18-153-06



Beckmann
DC18-153-01-
DC18-153-06
22 cm/8 3/4"



Asch
DC18-155-23
23 cm/9"
Septum Straightening
Forceps



Kressner
DC18-157-20
20 cm/8"

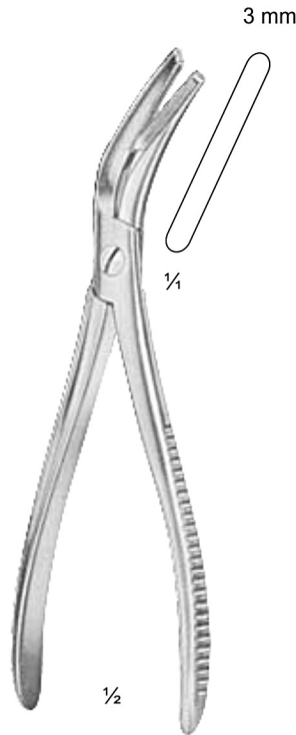

Joseph
DC18-159-18
18 cm/7"
Septum Punch Forceps



Cottle-Walsham
DC18-161-01 - DC18-161-03
23 cm/9"
Septum Straightening Forceps

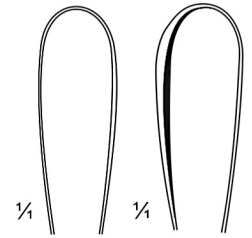

DC18-161-01 DC18-161-02



DC18-161-03



Ogura
DC18-163-11
Tissue Forceps



Cottle
DC18-165-14
Tissue Forceps



Hajek
DC18-167-15 = 1.5 mm \emptyset
DC18-167-20 = 2.0 mm \emptyset



Hartmann
DC18-169-20 = 2.0 mm \emptyset
DC18-169-25 = 2.5 mm \emptyset
DC18-169-30 = 3.0 mm \emptyset



Myles
1.8 mm \emptyset
DC18-171-09 = 9 cm/3 1/2"
DC18-171-10 = 10 cm/4"
DC18-171-11 = 11.5 cm/4 1/2"

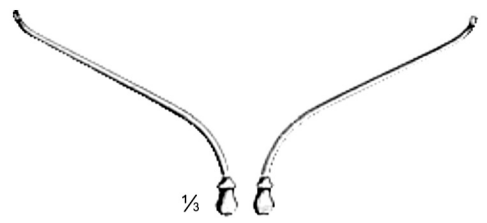

Hartmann
Fig. 1 mm \emptyset Fig. 2
DC18-173-20 2.0 DC18-175-20
DC18-173-25 2.5 DC18-175-25
DC18-173-30 3.0 DC18-175-30

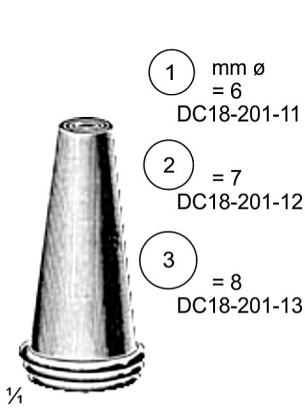

Troeltsch
for adults
Set of 3
Fig. 1-3 DC18-201-03

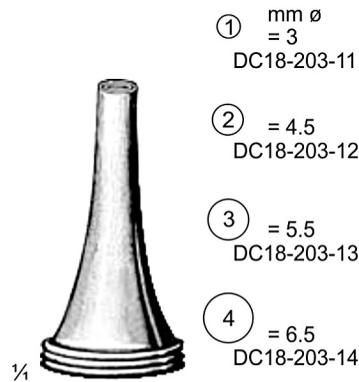

Poltzer
for adults
Set of 3
Fig. 2-4 DC18-203-03
Set of 4
Fig. 1-4 36-105-04



Hartmann
DC18-205-10
for babies

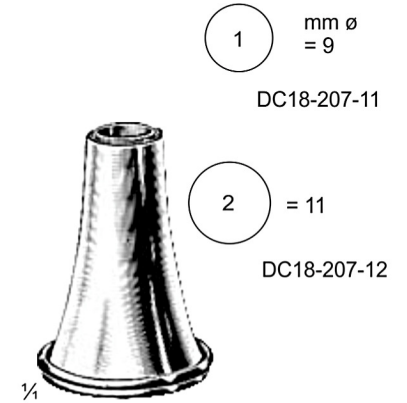

Hartmann
for postoperative treatment
Set of 2
Fig. 1-2 DC18-207-02

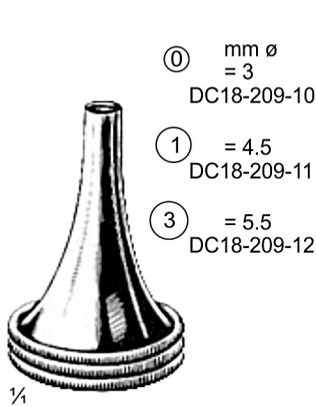

Hartmann
for children
Set of 3
Fig. 0-2 DC18-209-00

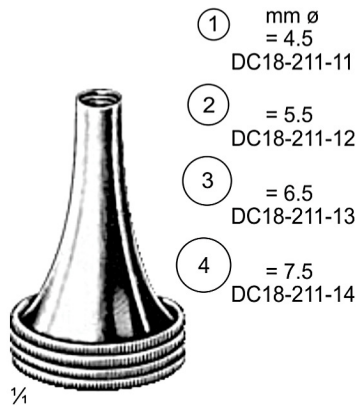

Hartmann
for adults
Set of 3
Fig. 2-4 DC18-213-03
Set of 4
Fig. 1-4 DC18-215-04

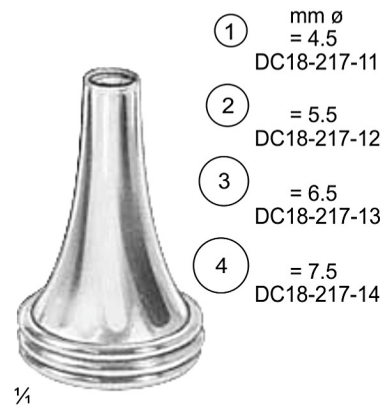

Toynbee
for adults
Set of 3
Fig. 2-4 DC18-219-03
Set of 4
Fig. 1-4 DC18-221-04



Hartmann
DC18-223-11
for children

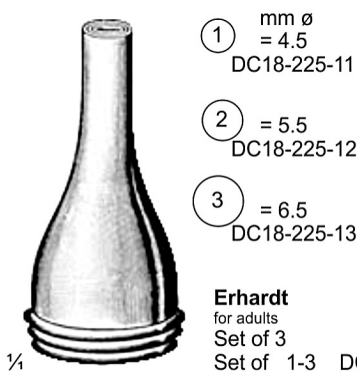

Erhardt
for adults
Set of 3
Set of 1-3 DC18-225-03

Gruber
for adults
Set of 3
Fig. 2-4 DC18-227-03
Set of 4
Fig. 1-4 DC18-229-04

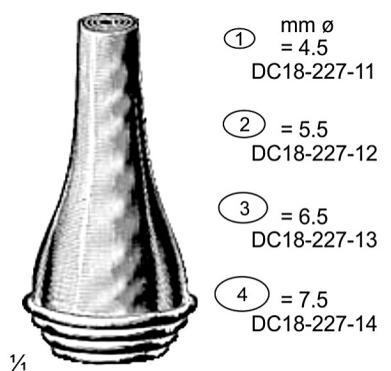

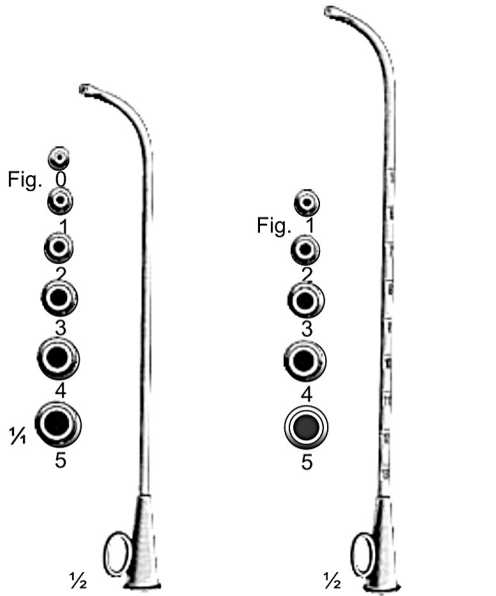

Fig.	Hartmann	Troeltsch
0	DC19-231-00	
1	DC19-231-01	DC19-233-01
2	DC19-231-02	DC19-233-02
3	DC19-231-03	DC19-233-03
4	DC19-231-04	DC19-233-04
5	DC19-231-05	DC19-233-05

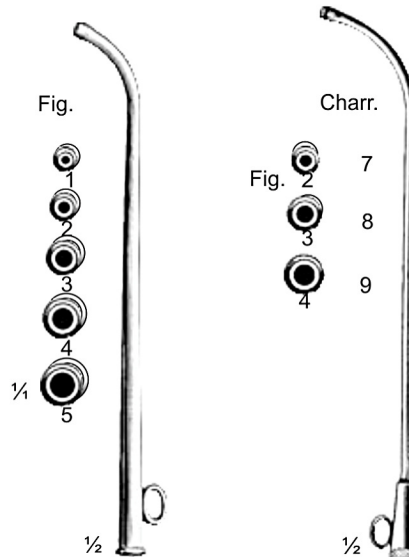
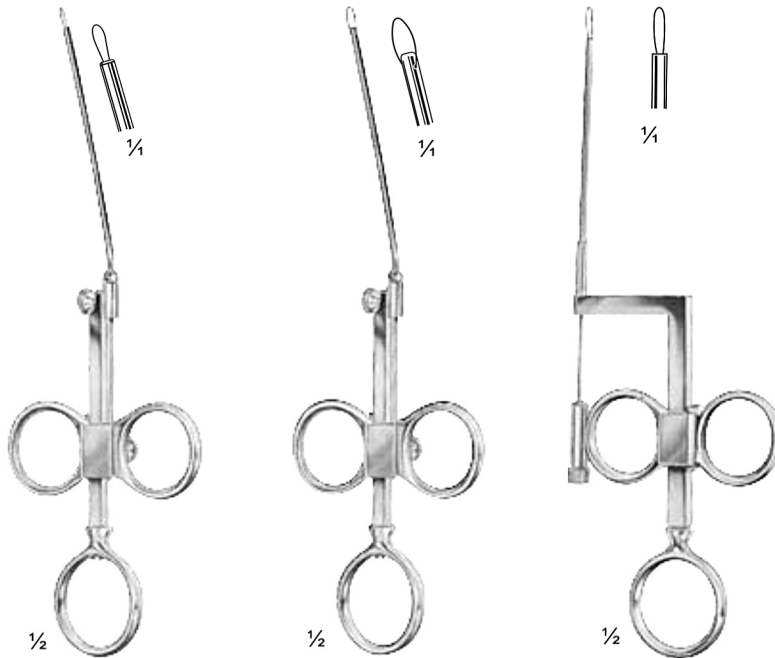

Fig.	Itard	Hartmann	Charriere
1	DC19-235-01		
2	DC19-235-02	DC19-237-02	7
3	DC19-235-03	DC19-237-03	8
4	DC19-235-04	DC19-237-04	9
5	DC19-235-05		



Krause
DC19-241-16

Krause-Voss
DC19-243-16

Lange-Wilde
DC19-245-17

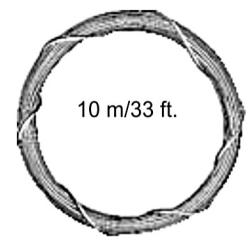

mm ø	
0.3	DC19-247-30
0.4	DC19-247-40



mm ø	
0.2	DC19-249-20
0.3	DC19-249-30

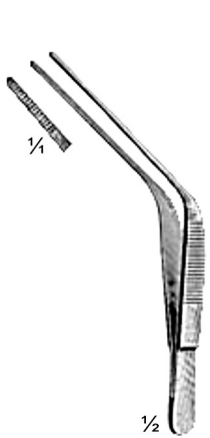

Troeltsch (Wilde)
DC18-251-11
11 cm / 4 1/2"

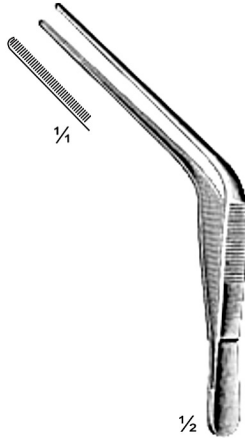

Troeltsch (Wilde)
DC18-253-12
12 cm / 4 3/4"



Troeltsch (Wilde)
DC18-255-13
13 cm / 5"



Lucae
DC18-257-14
14 cm / 5 1/2"



Jansen
DC18-259-16 = 16 cm / 6 1/4"
DC18-259-20 = 20 cm / 8"

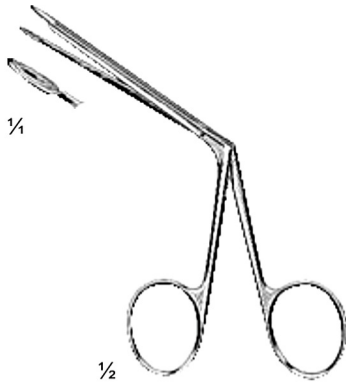

Littauer
DC18-261-12
12 cm / 4 3/4"
Ear Polypus Forceps

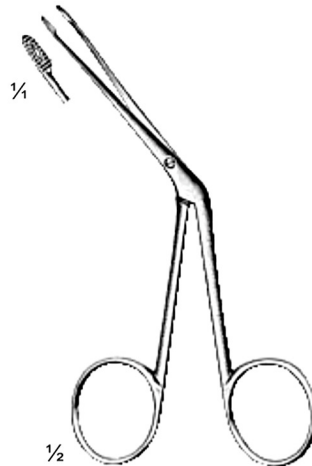

Hartmann
DC18-263-12
12 cm / 4 3/4"
fine pattern
Ear Polypus Forceps

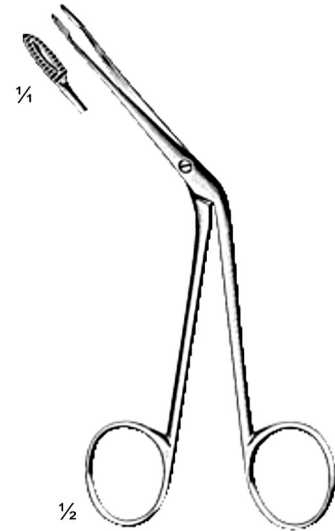

Hartmann
DC18-265-14
14 cm / 5 1/2"
standard pattern
Ear Polypus Forceps

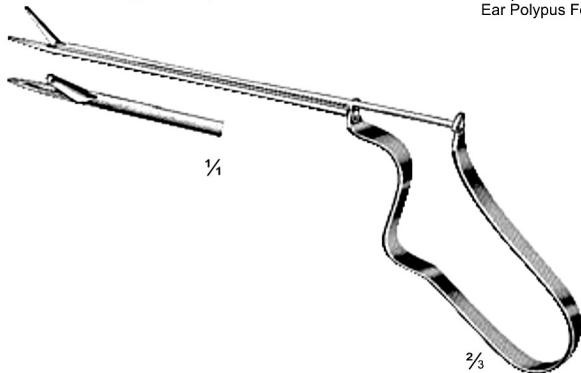

Buck
DC18-267-11
Foreign Body Levers

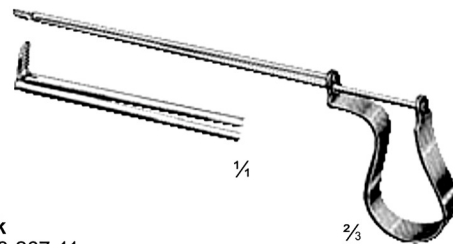

Quire
DC18-269-10
Foreign Body Levers

INTERNATIONAL CRIMSON

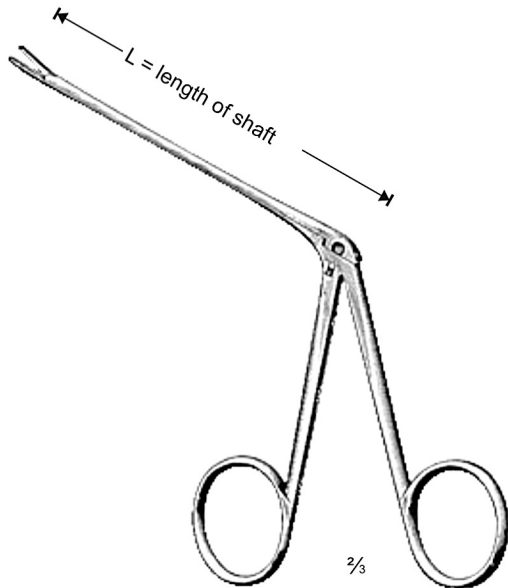

DC18-271-08 - DC18-297-08

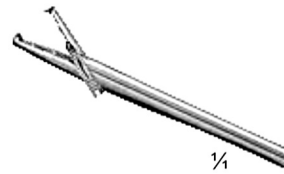

Hartmann
1 : 2
cm in. DC18-271-08
8.5 3 1/2 DC18-271-08
14 5 1/2 DC18-271-14

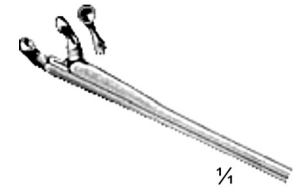

Hartmann
cm in. mm ø DC18-273-81
8.5 3 1/2 2 DC18-273-81
8.5 3 1/2 2.5 DC18-273-82
8.5 3 1/2 3 DC18-273-83

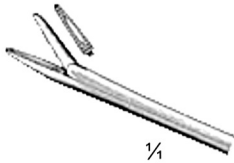

Hartmann
cm in. DC18-275-08
8.5 3 1/2 DC18-275-08
14 5 1/2 DC18-275-14
16.5 6 1/2 DC18-275-16

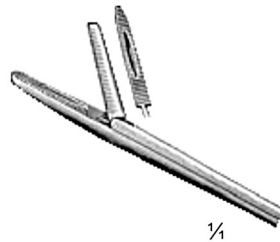

Hartmann-Noyes
DC18-277-09
9 cm/3 1/2"

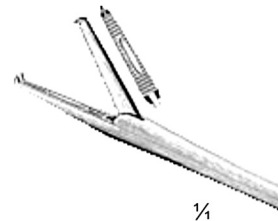

Hartmann-Noyes
DC18-279-09
9 cm/3 1/2"
1:2 teeth

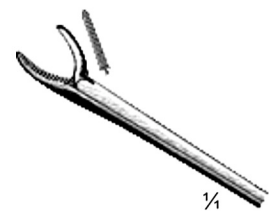

Hartmann-Weingartner
DC18-281-08
8.5 cm/3 1/2"

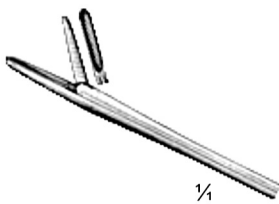

Hartmann
DC18-283-08
8.5 cm/3 1/2"

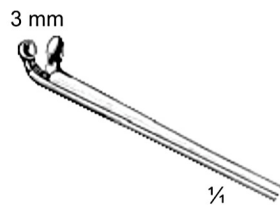

Hartmann
DC18-285-08
8.5 cm/3 1/2"

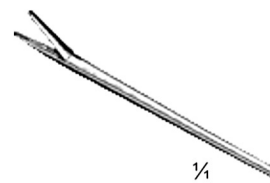

Hartmann-Wullstein
DC18-287-08
8.5 cm/3 1/2"

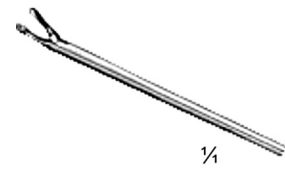

Hartmann-Wullstein
DC18-289-08
8.5 cm/3 1/2"

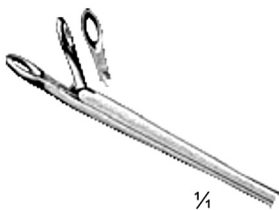

Struempel
DC18-291-08
8.5 cm/3 1/2"

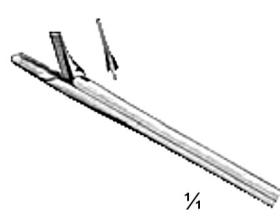

Hartmann
DC18-293-08
8.5 cm/3 1/2"
Punch action through-cutting,
also for foreign bodies

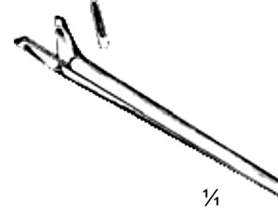

Hartmann
DC18-295-08
8.5 cm/3 1/2"
Punch action through-cutting,
also for foreign bodies

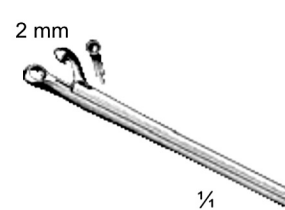

Hartmann-Hoffmann
DC18-297-08
8.5 cm/3 1/2"
Punch action through-cutting,
also for foreign bodies

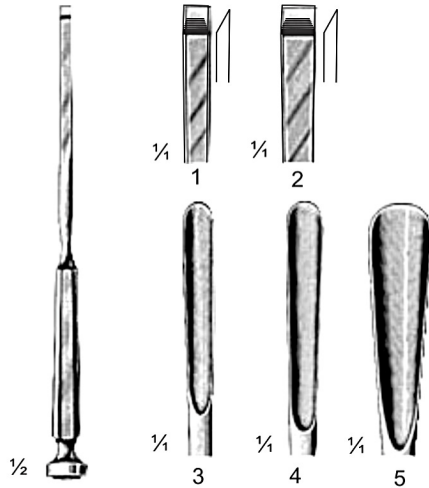

Fischer
12.5 cm / 5"
width

Fig. mm

1	4	DC18-299-04
2	5	DC18-299-05
3	4	DC18-301-04
4	5	DC18-301-05
5	9	DC18-301-09

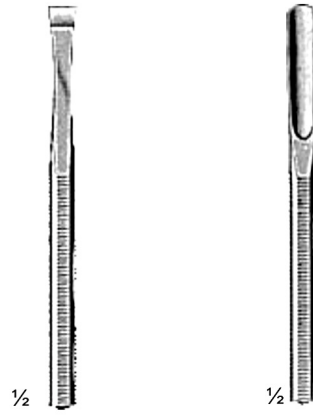

Schwartz
11 cm / 4 1/2"

width

chisels	mm	gouges
DC18-303-03	3	DC18-305-03
DC18-303-04	4	DC18-305-04
DC18-303-05	5	DC18-305-05
DC18-303-06	6	DC18-305-06
DC18-303-08	8	DC18-305-08



Stacke
DC18-307-12
12 cm / 4 3/4"
Protector and Guide



Langenbeck
DC18-309-13
13 cm / 5 1/4"



Citelli
DC18-311-17



Beyer
DC18-313-19

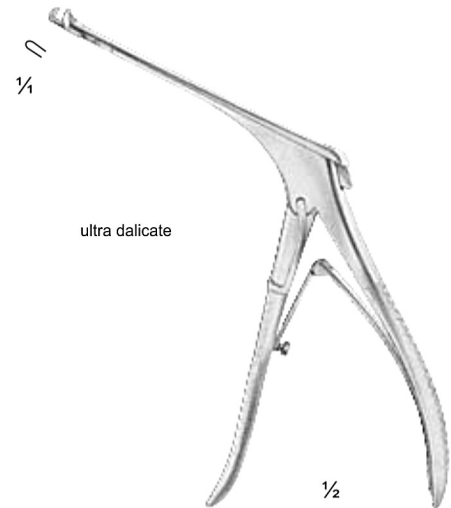

Beyer
DC18-315-14



Muck
DC18-317-13
13.5 cm / 5 1/2"
Periosteal Knife



Politzer
DC18-319-13
13.5 cm / 5 1/2"
Mastoid Knife



**Gerzog
Sexton**
DC18-320-17



Buck
DC18-321-16



DC18-322-16 - DC18-324-16
17 cm / 6 3/4"



Politzer
DC18-322-16



Gerzog
DC18-323-16



Buck
DC18-324-16

Instruments for Fenestration



Lempert
DC18-325-15
15 cm / 6"
Perforators



Lempert
15 cm / 6"
Perforators



DC18-326-15



DC18-327-15



Lempert
DC18-328-15
15 cm / 6"
Knives



Lempert
DC18-329-15
15 cm / 6"
Knives



Lempert
DC18-331-17
16.5 cm / 6 1/2"
Paracentesis Knife

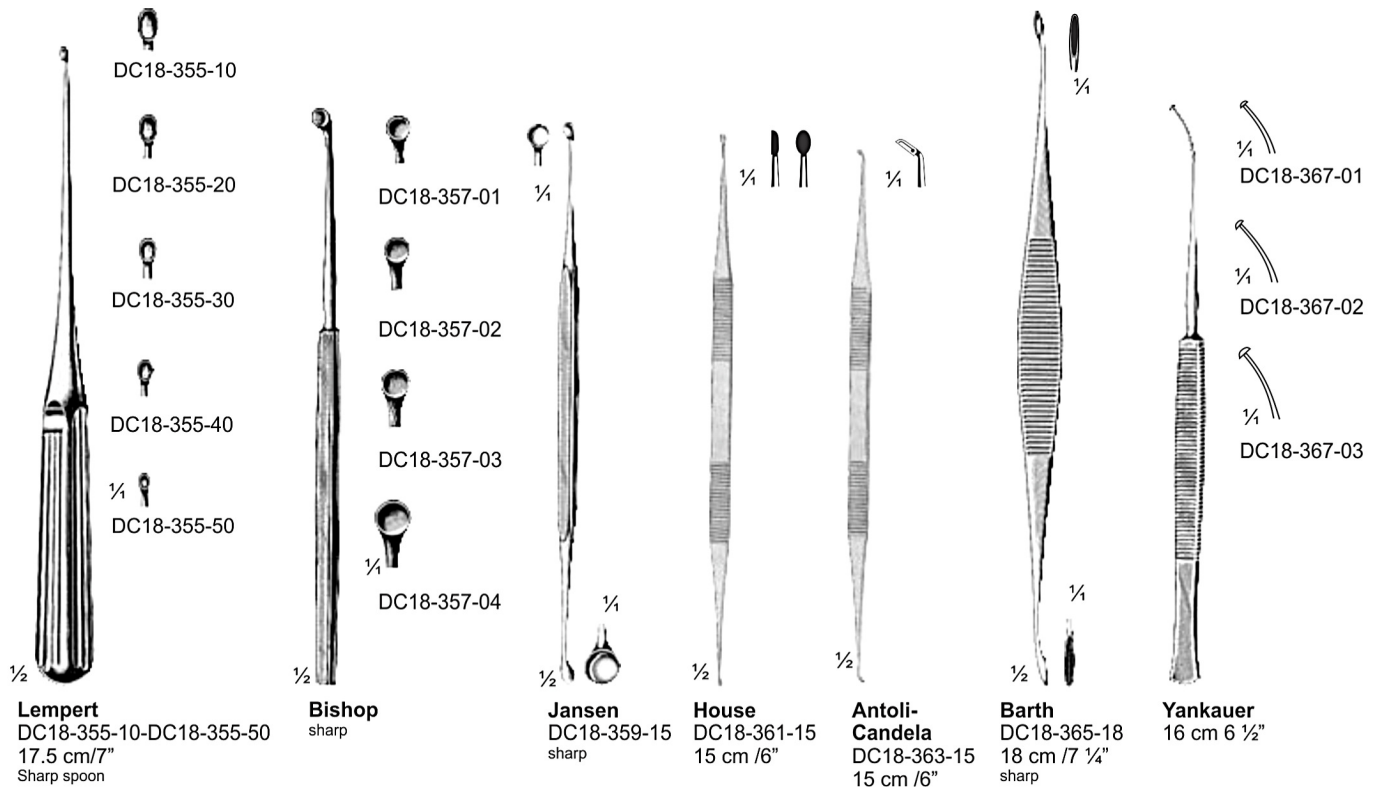
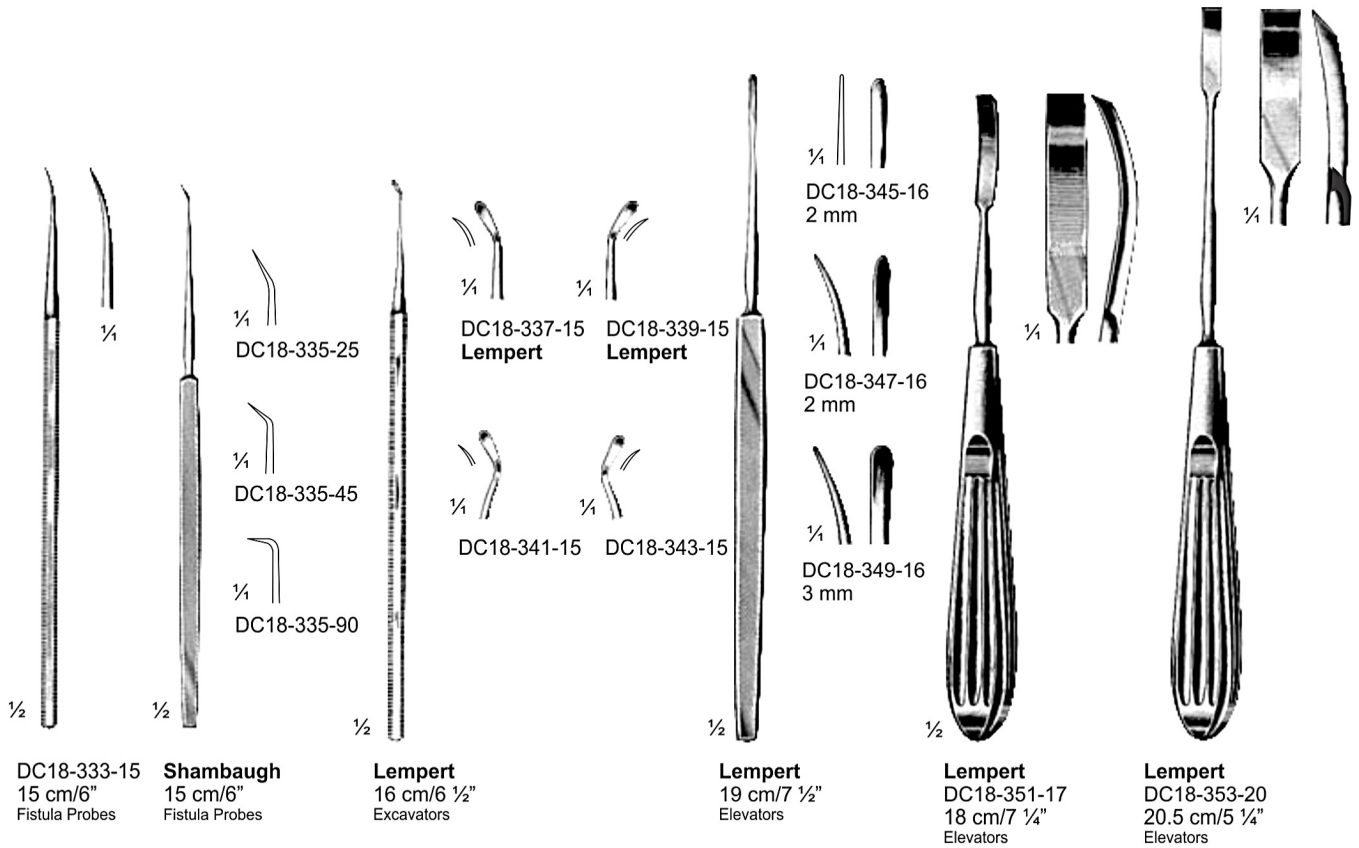



1/2
Roser
DC18-369-14
14 cm / 5 1/2"
blunt



1/2
Gross
DC18-371-12
12 cm / 4 3/4"
blunt / sharp



1/2
Gross
DC18-373-12
12 cm / 4 3/4"
blunt



1/2
Gross
DC18-375-12
12 cm / 4 3/4"
blunt



1/2
Gross
DC18-377-12
12 cm / 4 3/4"
blunt / sharp



1/2
Gross
DC18-379-12
12 cm / 4 3/4"

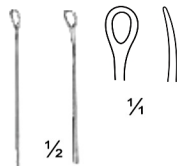

DC18-381-02

1/2
DC18-381-01
16 cm / 5 1/2"

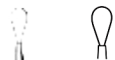

DC18-383-01



DC18-383-02



DC18-383-03

1/2
Billeau
16.5 cm / 6 1/2"
Loops



1/2
Moldenhauer
DC18-385-16
16.5 cm / 6 1/2"
Foreign Body Levers



1/2
Zaufal
DC18-387-16
16 cm / 6 1/2"
Foreign Body Levers



DC18-391-01 16.5 cm/6½"
 DC18-391-02 16.5 cm/6½"
 DC18-391-03 16.5 cm/6½"
 DC18-391-04 16.5 cm/6½"
 DC18-391-05 16.5 cm/6½"
 DC18-391-06 16.5 cm/6½"
 DC18-391-07 16.5 cm/6½"
 DC18-391-08 16.5 cm/6½"
 DC18-391-09 16.5 cm/6½"

1/4
 DC18-389-01
 16 cm/6½"

Mobilization Chisels

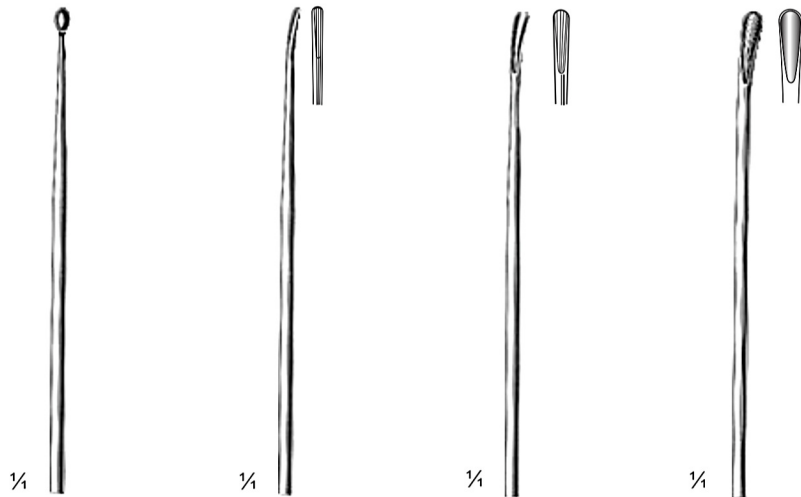

1/4
 DC18-393-01
 6.5 cm/2 3/4"

1/4
 DC18-395-01
 6.5 cm/2 3/4"

1/4
 DC18-395-02
 6.5 cm/2 3/4"

1/4
 DC18-395-03
 6.5 cm/2 3/4"

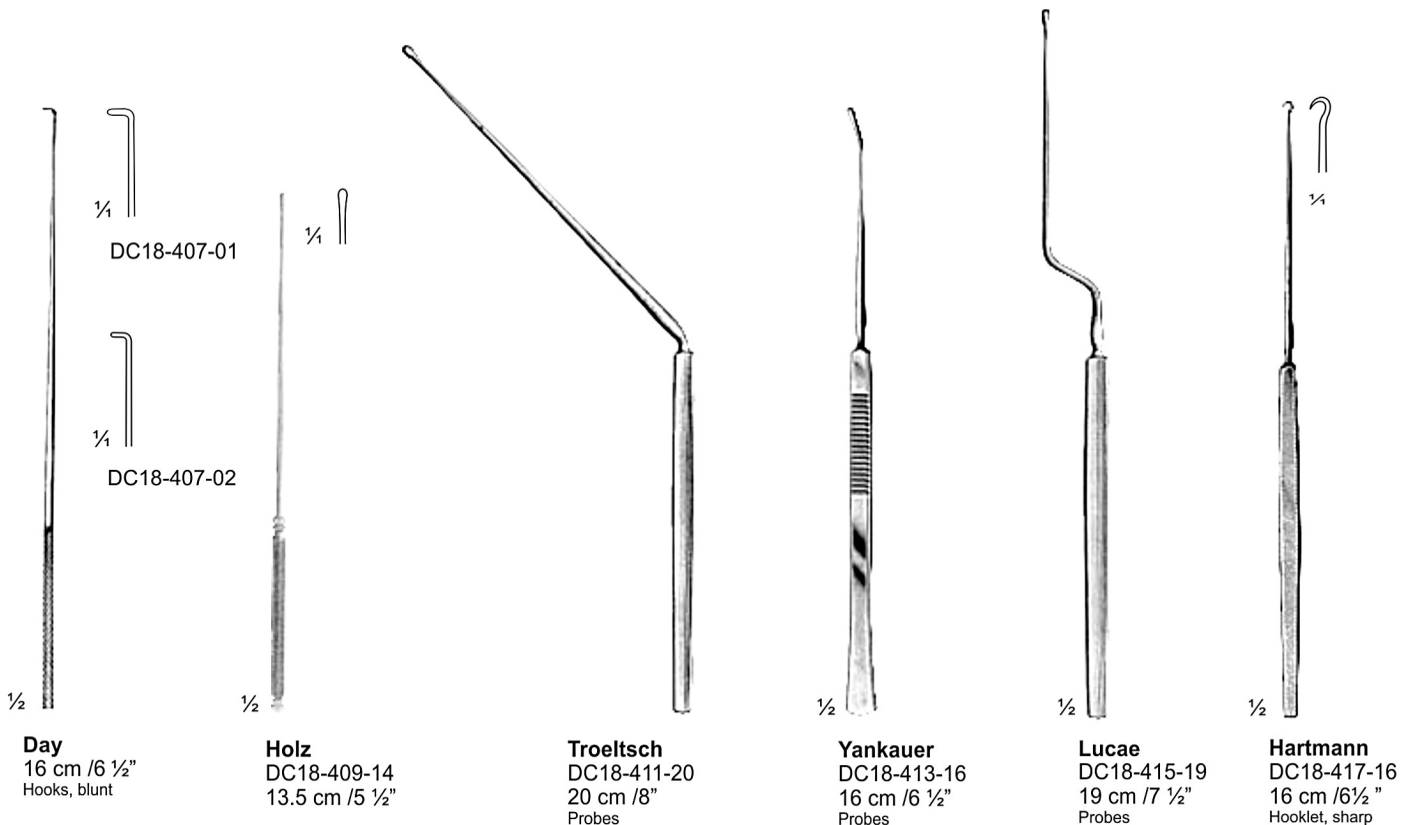
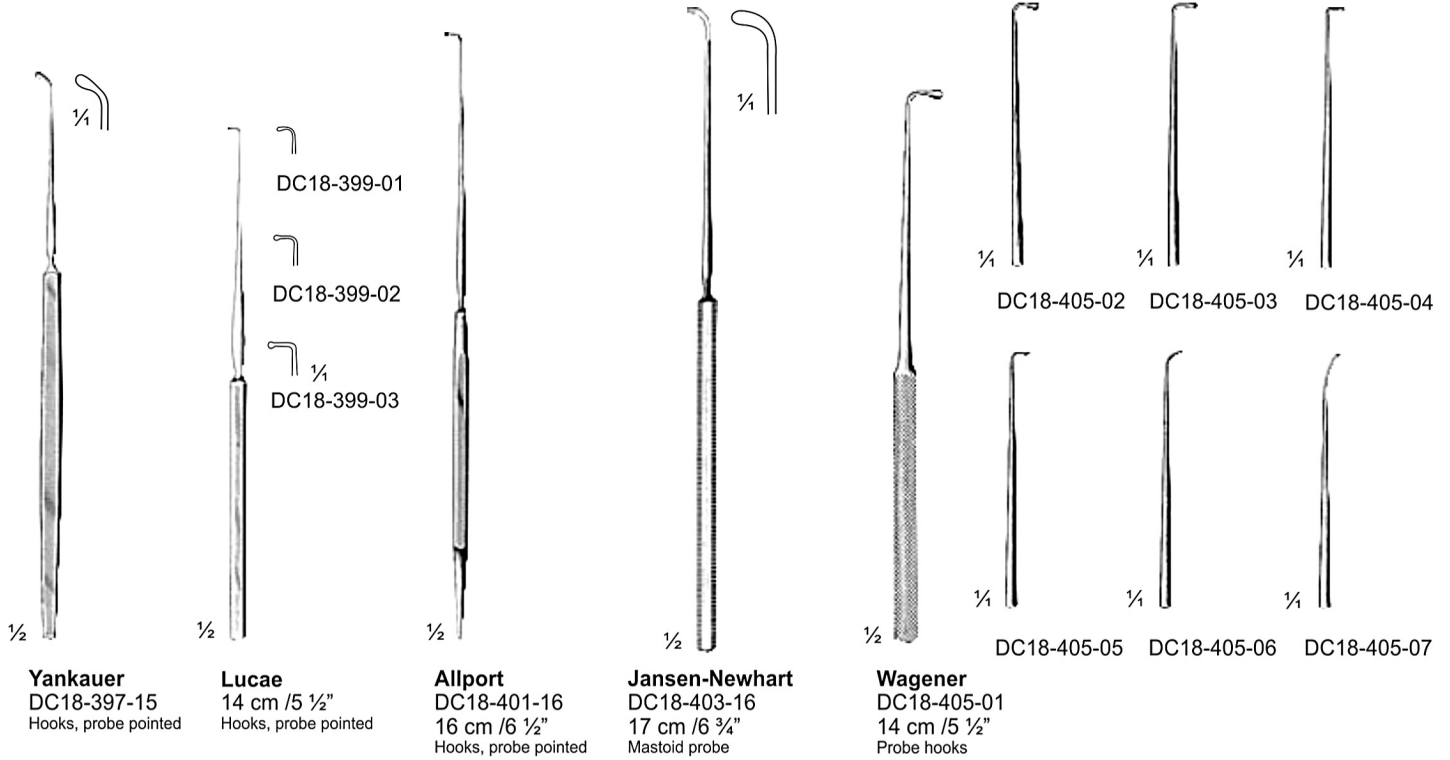

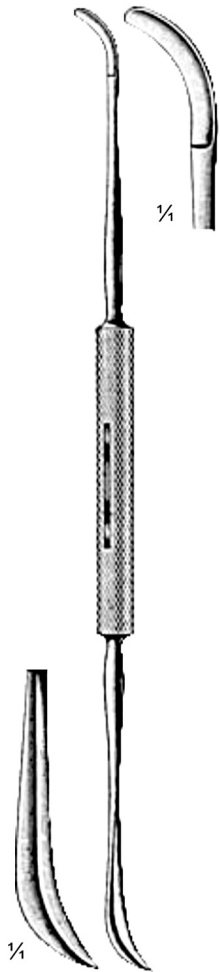

Harris
DC18-451-26
26 cm/10¹/₄"
Tonsil Knife and Dissectoe

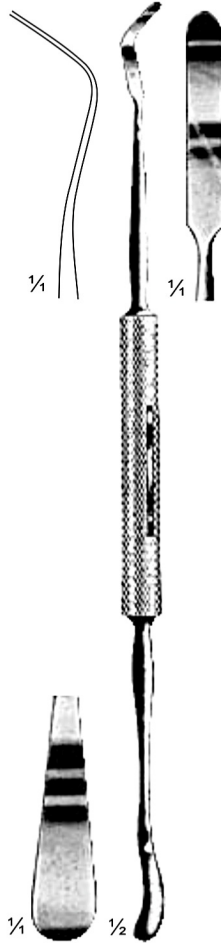

Carpenter
DC18-453-25
25 cm/10"
Tonsil Knife and Enuclcartor

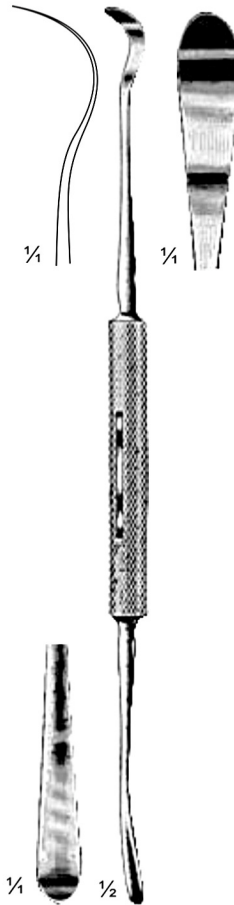

Carpenter
DC18-455-24
24 cm/9¹/₂"
Tonsil Knives
and Dissectors

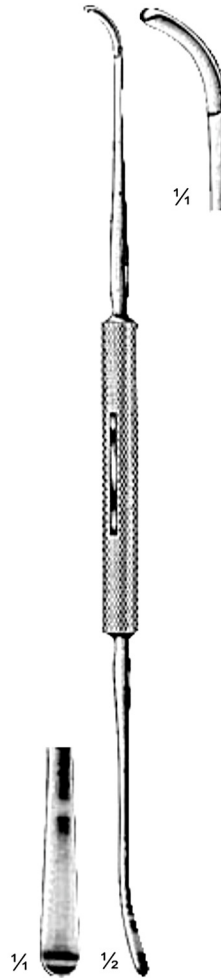

Milette
DC18-457-26
26 cm/10¹/₄"
Tonsil Knives
and Dissectors



Hurd
DC18-459-22
22.5 cm/9"
Tonsil Dissector
and Retractor



Yankauer
DC18-461-21
21 cm/8¹/₄"
Tonsil Elevator

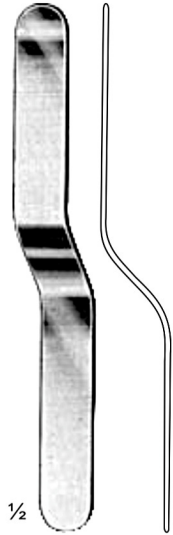

DC18-657-14
14.5 cm/5 3/4"



DC18-659-14
14.5 cm/5 3/4"



Doyen
DC18-661-13 = 13 cm/5"
DC18-661-16 = 16 cm/6 1/4"



Kroenig
DC18-663-15
15 cm/6"



Mayo
DC18-665-17
17 cm/6 3/4"



Bruenings
DC18-667-19
19 cm/7 1/2"



Collin
DC18-669-16
16.5 cm/6 1/2"



Mod. Martin
DC18-671-16
16.5 cm/6 1/2"

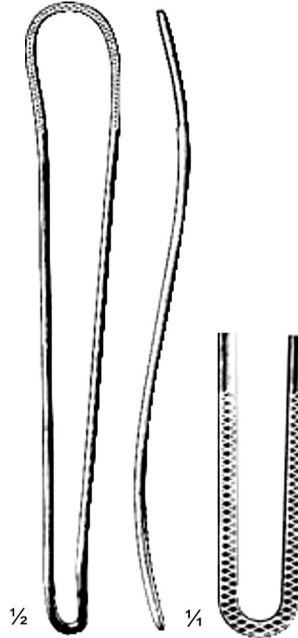

Frenzel
DC18-673-16
16.5 cm/6 1/2"



Tapia
DC18-675-19
19 cm/7 1/2"

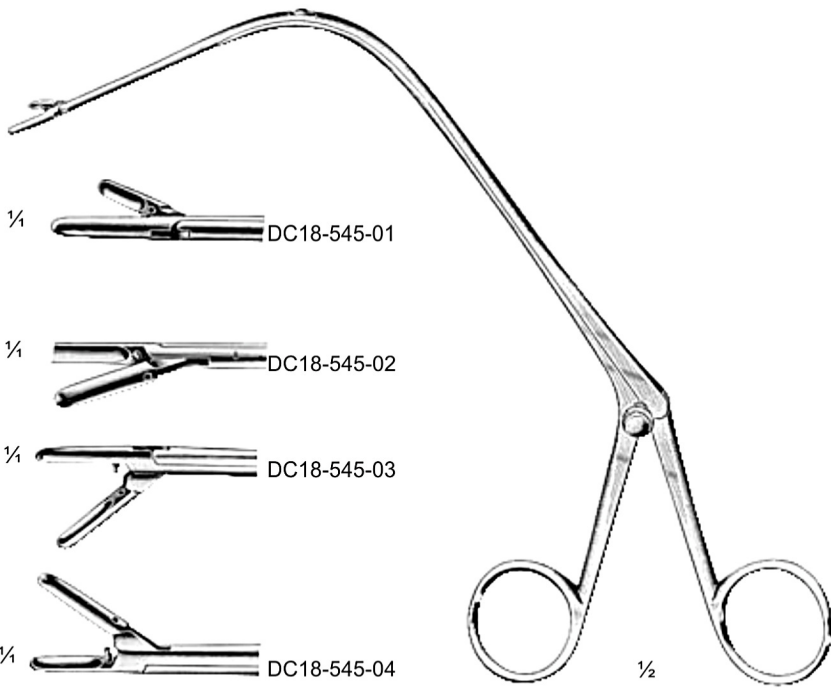

Jurasz
23 cm/9"
Laryngeal Polypus Forceps



Jackson
22 cm/8 3/4"
DC18-547-22
Applicator (Tampon)
Forceps, cross-action



Reichert
DC18-549-24
24 cm/9 1/2"
Epiglottis Retractor



Chevalier- Jackson

N
Fig. mm ø 45-90 mm

0	4	DC18-551-04
1	5	DC18-551-05
2	6	DC18-551-06
3	7	DC18-551-07
4	8	DC18-551-08
5	9	DC18-551-09
6	10	DC18-551-10
7	11	DC18-551-11
8	12	DC18-551-12
9	13	DC18-551-13

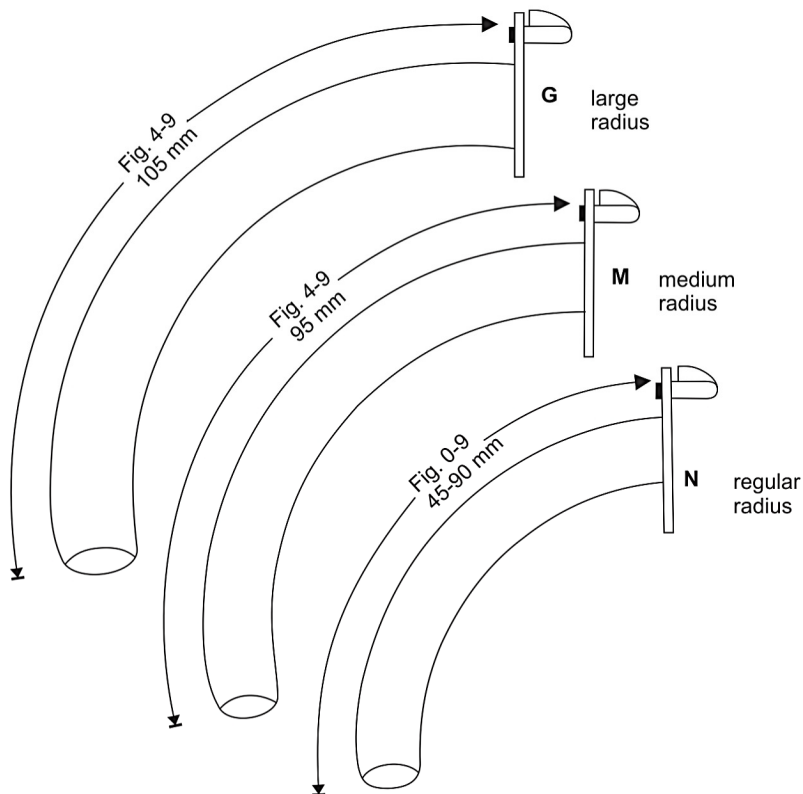
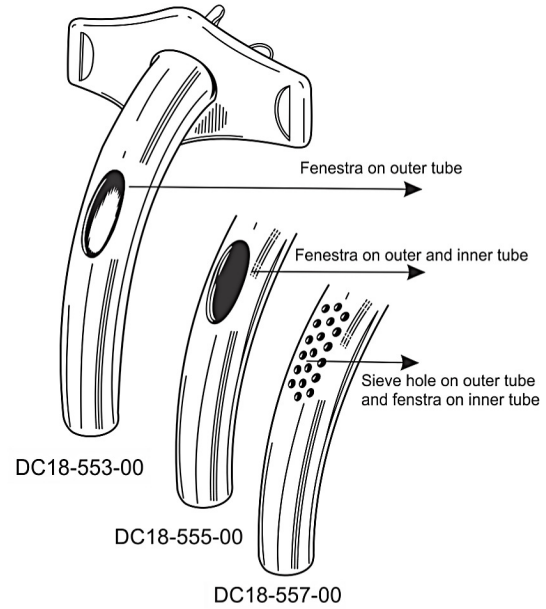

standard pattern

Luer	N	M	G	
Fig.	mm ø 45-90 mm	95 mm	105 mm	
0	4	DC18-559-04		
1	5	DC18-559-05		
2	6	DC18-559-06		
3	7	DC18-559-07		
4	8	DC18-559-08	DC18-561-08	DC18-563-08
5	9	DC18-559-09	DC18-561-09	DC18-563-09
6	10	DC18-559-10	DC18-561-10	DC18-563-10
7	11	DC18-559-11	DC18-561-11	DC18-563-11
8	12	DC18-559-12	DC18-561-12	DC18-563-12
9	13	DC18-559-13	DC18-561-13	DC18-563-13

INTERNATIONAL CRIMSON



Bose
DC18-565-16
16 cm / 6 1/4"



Bose
DC18-567-16
16 cm / 6 1/4"

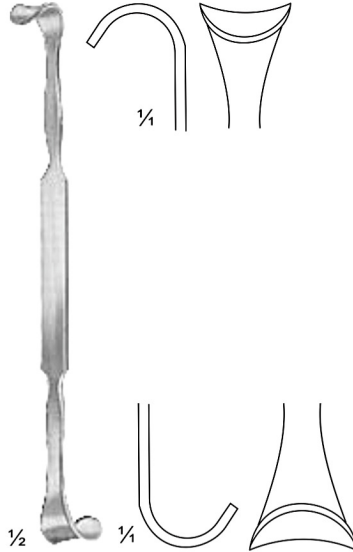

Rose
DC18-569-13
13 cm / 5"

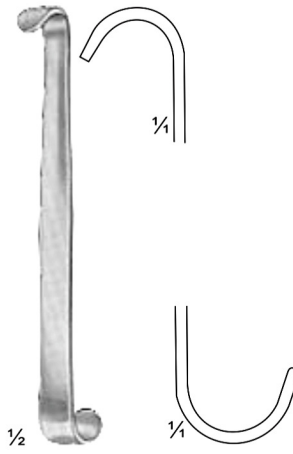

Luer
DC18-571-11
11 cm / 4 1/2"
Trachea Retractors



Jackson
DC18-573-15
15 cm / 6"
Trachea Tenaculum



DC18-575-15
15 cm / 6"



Lukens
DC18-577-17
17 cm / 6 3/4"
Thymus Retractor,
double-ended

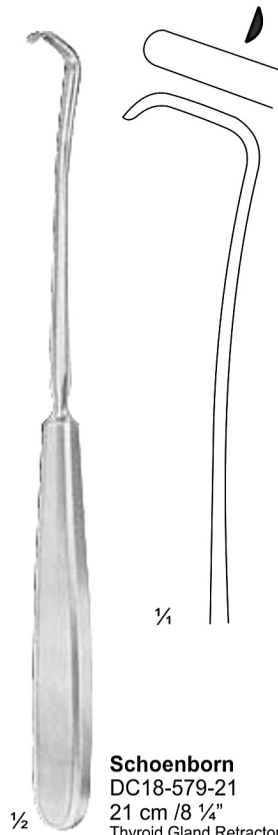

Schoenborn
DC18-579-21
21 cm / 8 1/4"
Thyroid Gland Retractor



Bose
DC18-581-07
7 cm / 2 3/4"

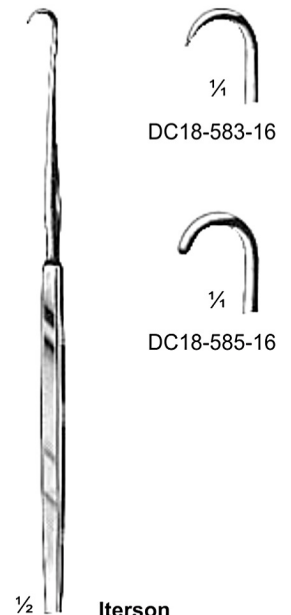

DC18-583-16

DC18-585-15

Iterson
Trachea Retractors

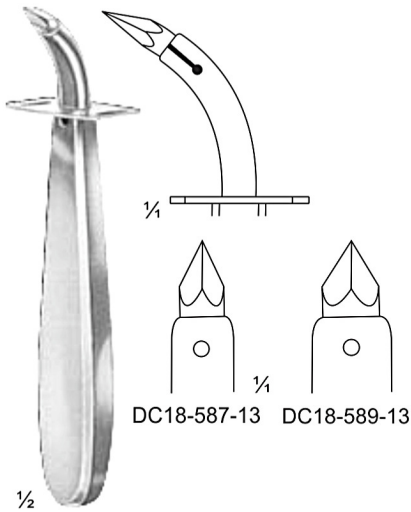

DC18-587-13 DC18-589-13

Uckermann
 DC18-587-13 = 8 mm \varnothing
 DC18-589-13 = 10 mm \varnothing
 13 cm / 5"
 Trachea Trocars for Inter- cricothyrotomy,
 with stainless steel point, cannula of silver 835



Weerda
 DC18-591-19
 19 cm / 7 1/2"
 Tracheotomy Spreader

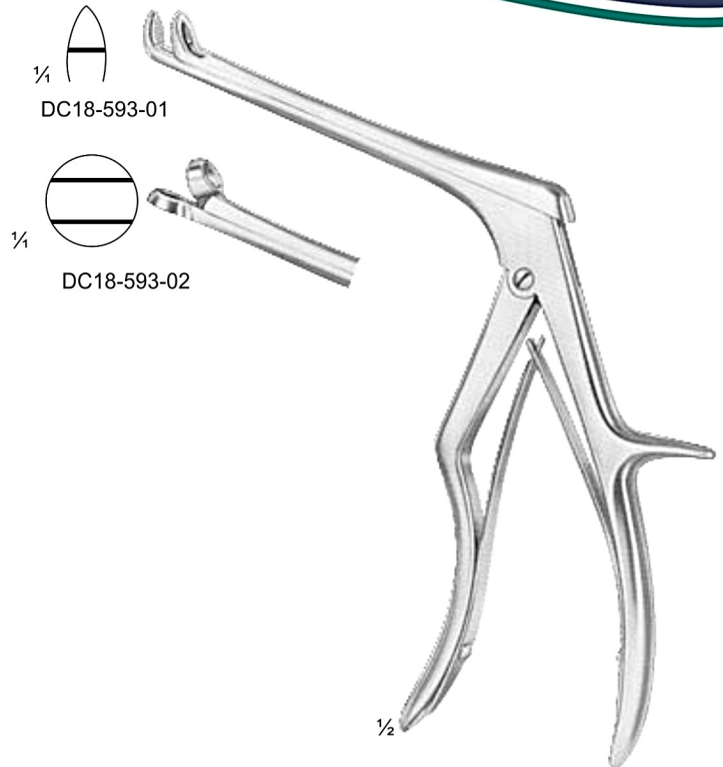

DC18-593-01

DC18-593-02

DC18-593-01 - DC18-593-02
 Tracheotomy Punches

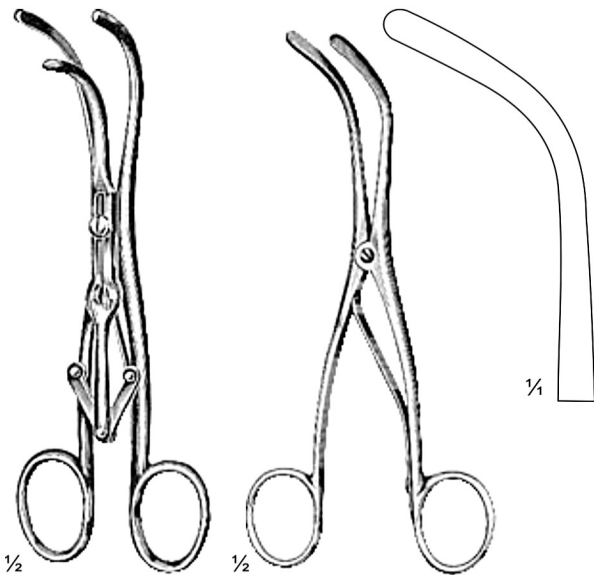

Laborde
 DC18-595-14
 14 cm / 5 1/2"
 Trachea Dilators

Trousseau
 DC18-597-14
 14 cm / 5 1/2"
 Trachea Dilators



Jakson
 DC18-599-17
 17 cm / 6 3/4"
 Trachea Retractors, double-ended



Jakson
 DC18-601-18
 18 cm / 7"
 blunt
 Trachea Retractors, double-ended

DC18-603-18
 sharp

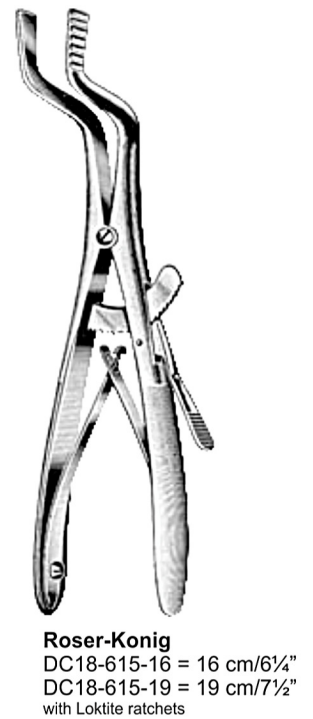
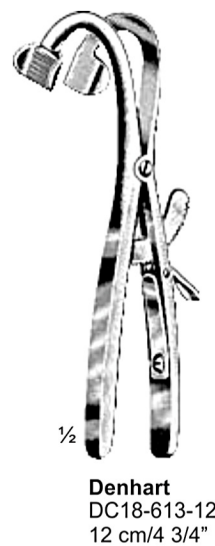
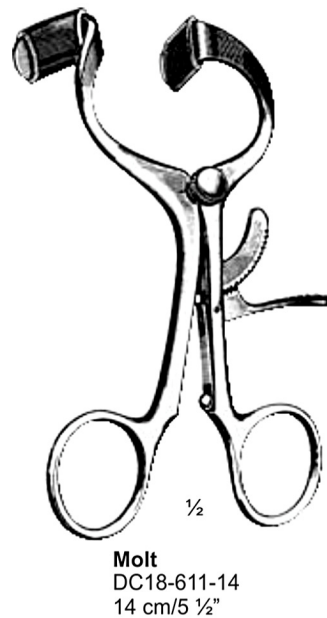
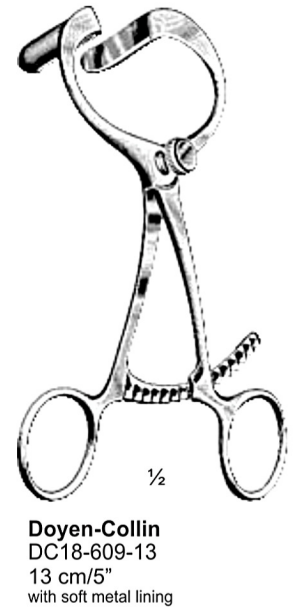
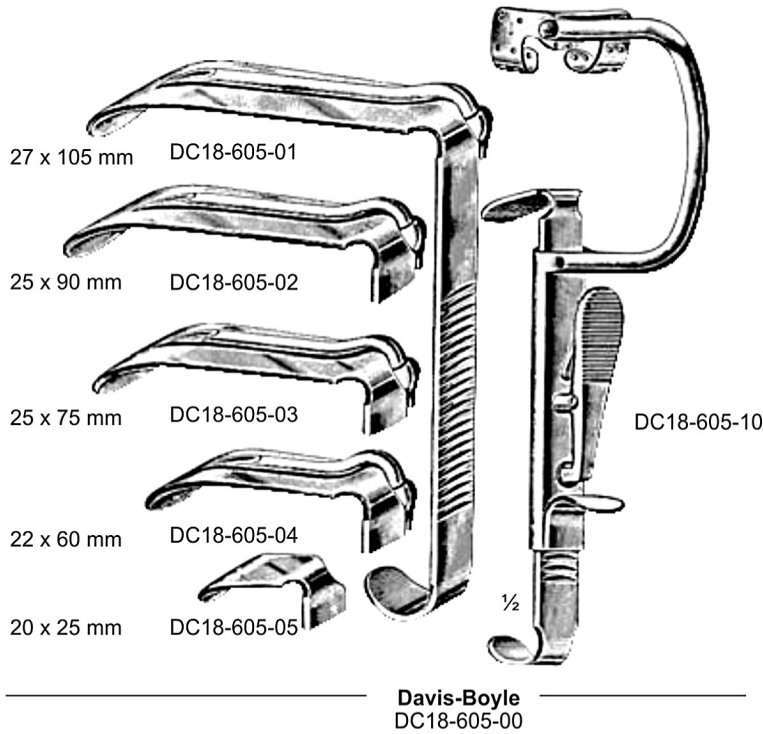

DC18-605-00 - complete with frame (handle) and 5 interchangeable tongue depressors.
 DC18-605-01 - DC18-605-05 - Tongue Depressors only
 DC18-605-10 - Frame (Handle) only

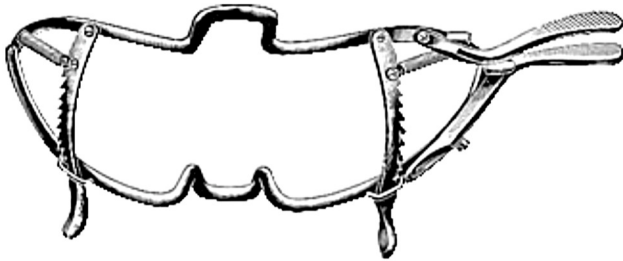

Whitehead
 DC18-617-11 = 11 cm/4¼"
 DC18-617-13 = 13 cm/5"
 DC18-617-15 = 15 cm/6"
 with one lateral handle,
 without tongue depressor

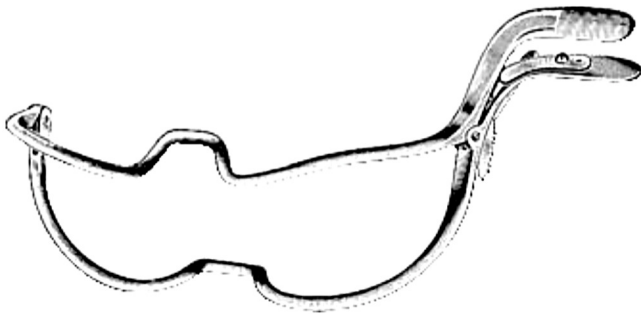

Jennings
 DC18-619-09 = 9 cm/3½"
 DC18-619-11 = 11 cm/4½"
 DC18-619-13 = 13 cm/5"
 DC18-619-15 = 15 cm/6"
 with one lateral handle,
 without tongue depressor, with Loktite ratchet

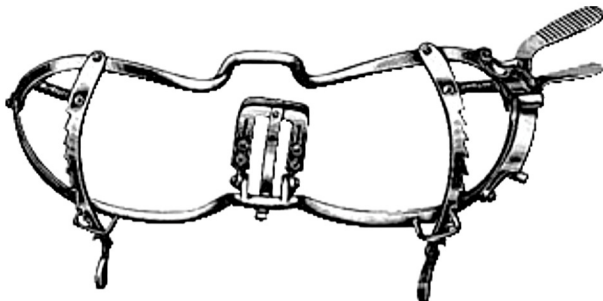

Whitehead
 DC18-623-13
 13 cm/5"
 with one lateral handle,
 with tongue depressor

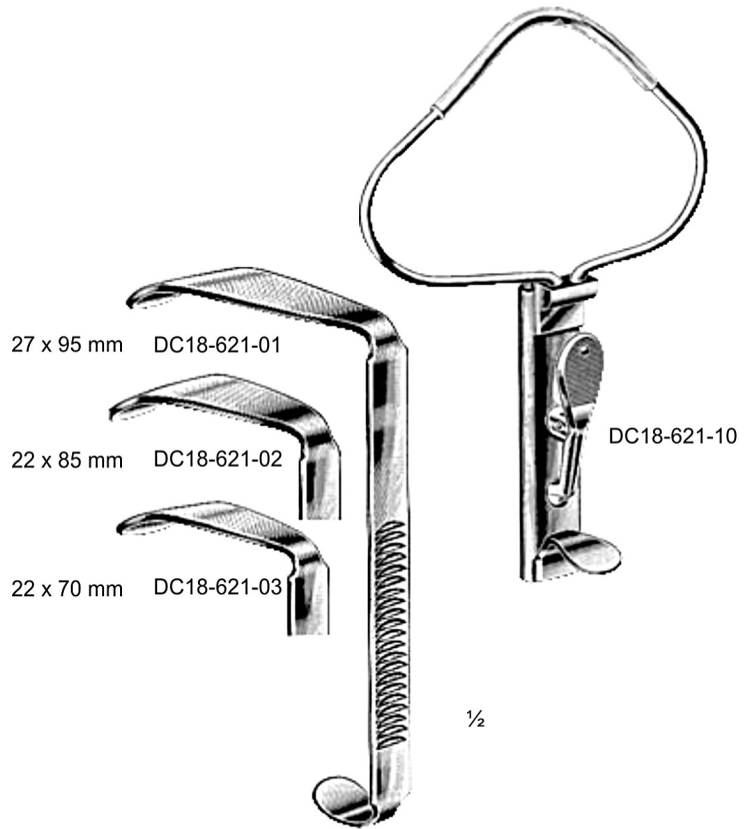

27 x 95 mm DC18-621-01

22 x 85 mm DC18-621-02

22 x 70 mm DC18-621-03

DC18-621-10

½

McIvor
 DC18-621-00

DC18-621-00

complete with frame (handle) and 3 interchangeable tongue depressors, without anaesthetic tube

DC18-621-01 - DC18-621-03

Tongue Depressors only

DC18-621-10

Frame (Handle) only



Moritz-Schmidt
DC18-639-19
19 cm/7½"
hollow
Tongue Depressors



Hartmann
DC18-641-15
15 cm/6"
Tongue Depressors

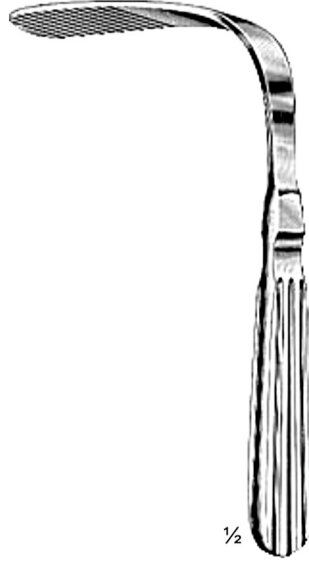

Tobold
DC18-643-14
14.5 cm/5½"
solid
Tongue Depressors

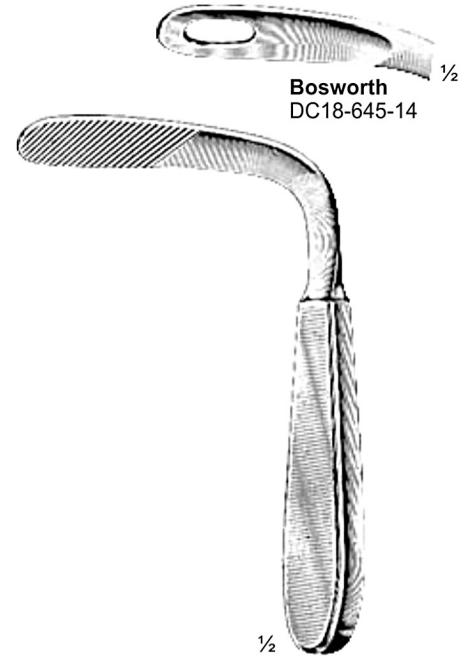

Bosworth
DC18-645-14

Tobold
DC18-647-14
14.5 cm/5½"
hollow
Tongue Depressors



Tobold
DC18-649-02
12 cm/4¾"
folding type



Andrew
DC18-651-11
11 cm/4½"

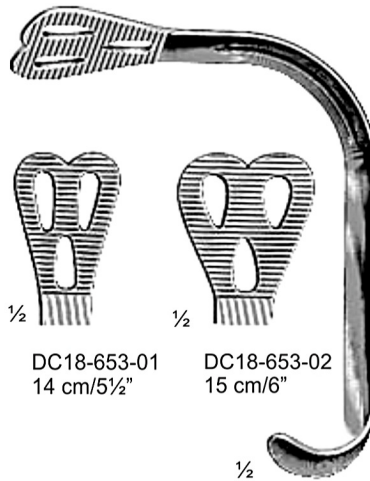

DC18-653-01
14 cm/5½"

DC18-653-02
15 cm/6"

Wieder

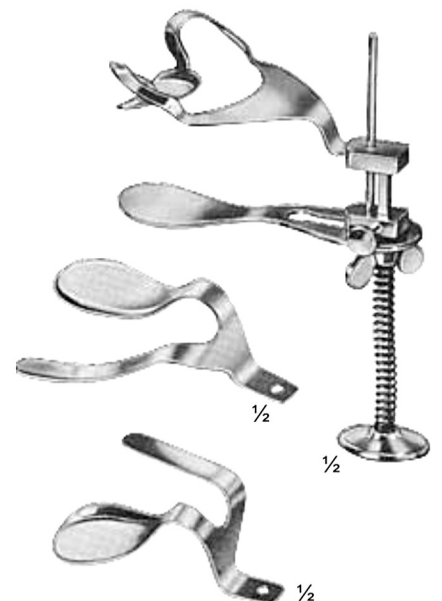

Martin-Zuwafix
DC18-655-00
Tongue Depressor and Cotton
Roll Holder, with Chin Holder

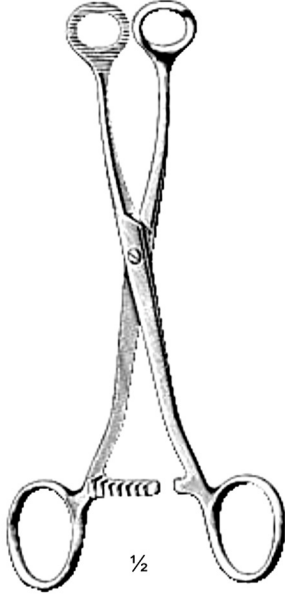

Collin
DC18-677-16
16 cm/6 1/4"

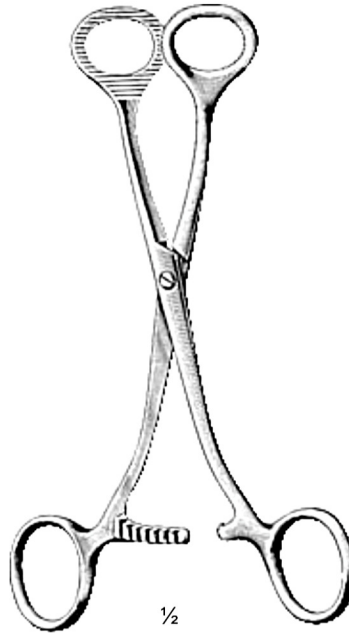

Collin
DC18-679-17 = 17 cm/6 3/4"
DC18-679-19 = 19 cm/7 1/2"



Guy
DC18-681-19
19 cm/7 1/2"

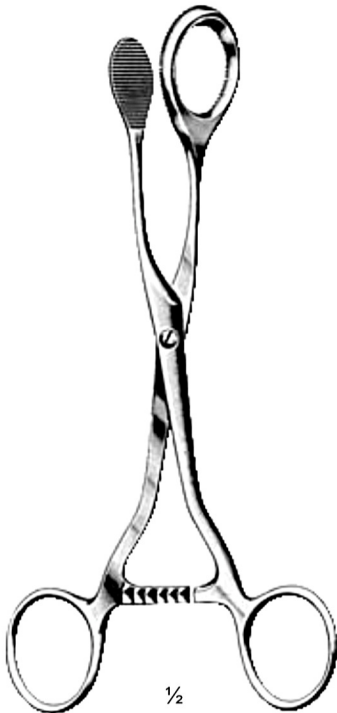

Mathieu
DC18-683-19
19 cm/7 1/2"

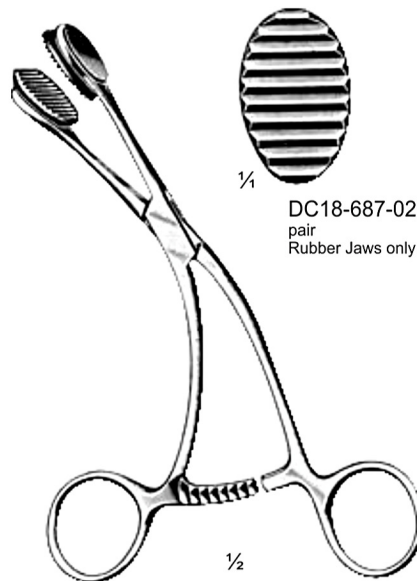

Young
DC18-685-17
17 cm/6 3/4"
with interchangeable toothed rubber jaws

DC18-687-02
pair
Rubber Jaws only